

# Stepwise Electrophilic Addition. Some Novel Synthetic Ramifications of an Old Concept

William A. Smit,<sup>†</sup> Ron Caple,<sup>‡</sup> and Irina P. Smoliakova<sup>‡</sup>

Zelinsky Institute of Organic Chemistry, Russian Academy of Science, Leninsky pr., 47, Moscow, Russia, and Department of Chemistry, University of Minnesota, Duluth, Duluth, Minnesota 55812

Received May 9, 1994 (Revised Manuscript Received September 12, 1994)

## Contents

I. Introduction	2359
II. Classical Mechanism of the Ad <sub>E</sub> Reaction and Its Ramifications. Cationoid vs Covalent Electrophiles	2359
III. Two-Step Ad <sub>E</sub> Reaction Based on the Use of Electrophiles Capable of Forming Bridged Carbocationic Intermediates (Case A)	2362
IV. Two-Step Ad <sub>E</sub> Reaction with Unsaturated Substrates Containing an Adjacent Cation Stabilizing Group (Case B)	2370
V. Concluding Remarks	2379
VI. Abbreviations	2380
VII. Acknowledgments	2380
VIII. References	2380

## I. Introduction

The strategy of modern organic synthesis is especially focused on the incorporation of convergency points into protocols designed for the preparation of complex molecules. One of the most reliable and generally applicable approaches to this goal takes advantage of the well-elaborated method of the stepwise Ad<sub>N</sub> reaction across a multiple bond conjugated with electron-withdrawing groups (EWG). In this process an initial addition of a nucleophile (Nu) results in the formation of stabilized carbanionoid intermediates (CAI) as kinetically independent species which can be further quenched with an arbitrarily chosen external electrophile (E<sub>ext</sub>)<sup>1a</sup> (see general equation in Scheme 1).

Both carbon nucleophiles (Nu<sub>C</sub>) and carbon electrophiles (E<sub>C</sub>) can be utilized as addends and hence this three-component one-pot coupling can lead to the formation of two novel C–C bonds. The opportunity to vary all participating components in conjunction with a generally high efficiency and stereoselectivity of the overall coupling offers numerous promising options for the elaboration of convergent routes for the synthesis of polyfunctional compounds which can be utilized as advanced intermediates in a total synthesis.<sup>1a–d</sup> An impressive number of spectacular achievements in this area amply illustrates the fruitfulness of this protocol which, in fact, was developed due to the thoughtful consideration of the known mechanistic interpretation of the course of the Ad<sub>N</sub> reaction.

A basically complementary and potentially no less useful sequence of addition could have been envisaged using a stepwise Ad<sub>E</sub> approach. However, in striking contrast with the feverish activity in the Ad<sub>N</sub> field, very few systematic studies have been carried out in the area of stepwise Ad<sub>E</sub> reactions, and as yet its potential remains largely unexplored. Some time ago we initiated studies specifically targeted to fill this gap<sup>2</sup> and in the present review we have summarized the main results which, as we see it, attest to the promise of this approach. It is to be emphasized that we deliberately limited the coverage to the studies which were specifically aimed at the performing of an Ad<sub>E</sub> reaction as a truly stepwise process, consisting of the sequence of kinetically independent steps. Ample data referring to the other aspects of the preparative application of the Ad<sub>E</sub> process are beyond the scope of the present review.

## II. Classical Mechanism of the Ad<sub>E</sub> Reaction and Its Ramifications. Cationoid vs Covalent Electrophiles

The stepwise mechanism of the Ad<sub>E</sub> reaction was first advanced in the early 1920s and since then it has been widely used for the description of the interaction of alkenes and alkynes with various electrophilic species.<sup>3a</sup> This concept, additionally refined by more recent suggestions about the structural diversity of carbocationic intermediates (CCI) presumably formed upon the initial attack of electrophilic moieties across a multiple bond,<sup>3b</sup> turned out to be extremely helpful for the understanding of the kinetical peculiarities as well as product-selectivity, stereoselectivity, and regioselectivity patterns of the manifold of Ad<sub>E</sub> reactions. At the same time there were very serious doubts related to the basic adequacy of this mechanism and one of the main proponents of the carbocationic descriptions, Sir Robert Robinson, never missed the opportunity to emphasize his concerns about a too literal utilization of this concept. It was rather typical of him to warn: "...I have no objections to carbonium ions being written down so long as you know that they do not exist. They are simply a useful summary of a concerted process."<sup>4</sup> These reservations referred first of all to the main postulate of the stepwise description of the Ad<sub>E</sub> reaction which assumes the formation of *carbocationic species as discreet intermediates* upon the interaction of two covalent reactants in regular solvents of moderate polarity and substantial nucleophilicity. In fact, there is virtually no truly direct evidence justifying a claim that any of the traditional

<sup>†</sup> Zelinsky Institute of Organic Chemistry.

<sup>‡</sup> University of Minnesota, Duluth.

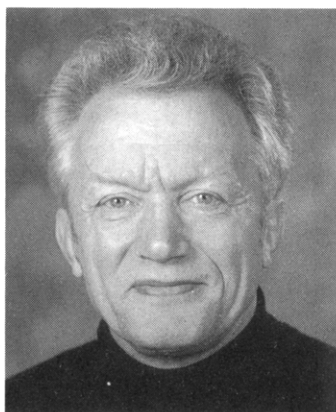

William A. Smit was born in Moscow, USSR, in 1931. He received his Diploma degree from Moscow State University in 1953 and obtained his Ph.D. under the direction of Professor I. N. Nazarov at the Zelinsky Institute of Organic Chemistry in Moscow in 1958. He earned the Doctor of Science distinction in 1972 and received the prestigious Butlerov Award in the same year from the Soviet Academy of Sciences. He is the author of over 170 publications. His main research areas are biometric isoprenoid cyclizations and novel approaches to organic syntheses. He is presently head of the department of organic chemistry at the Higher College of Chemistry of the Russian Academy of Science.

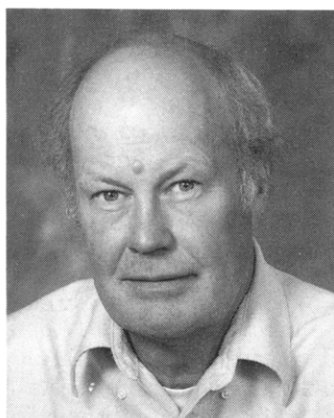

Ron Caple was born in International Falls, MN, in 1937. He received his B.A. degree from St. Olaf College in 1960 and his Ph.D. in chemistry from the University of Michigan (Wyman R. Vaughan) in 1964. He had a postdoctoral appointment at the University of Colorado (Stanley J. Cristol) before joining the University of Minnesota, Duluth in 1965 where he is presently a Professor of Chemistry. His research involves the development of new electrophilic reagents and the utilization of electrophilic reagents in organic synthesis. He has actively collaborated with his Russian colleagues for 20 years and in 1993 was elected Doctor Honoris Causa of the Russian Academy of Sciences. He is a strong supporter of the Council on Undergraduate Research and is presently chair of the Chemistry Division of CUR.

$Ad_E$  reactions performed under conventional conditions would proceed via an energetically very costly ionic route, bypassing a plethora of more or less concerted (and much cheaper!) pathways.

At the same time the above reasoning stimulated the formulation of a challenging problem:<sup>2</sup> is it possible to design conditions and/or reactants which would force an  $Ad_E$  reaction to follow the course prescribed to it by theory, i.e. to proceed as a sequence of two independent chemical events, first, an addition of an electrophilic species with a formation of the kinetically stable CCI, and second, the reaction of the latter species with some arbitrarily chosen external nucleophile ( $Nu_{ext}$ ) as shown in Scheme 2?



Irina P. Smoliakova was born in Moscow, USSR, in 1961. She received a Diploma degree from Moscow State University in 1983 and a Ph.D. from the Zelinsky Institute of Organic Chemistry, Soviet Academy of Science, in 1989, working with Professor W. A. Smit. She is presently a postdoctoral associate at University of Minnesota, Duluth. Her research interests include stereoselective synthesis and synthetic carbohydrate chemistry.

### Scheme 1

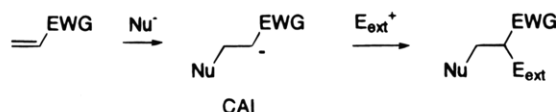

### Scheme 2

#### Classical $Ad_E$ mechanism

E-Nu: covalent, weakly polarized reagents,  
 $Nu_{ext}$ : compatible with E-Nu

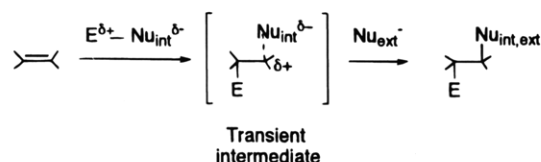

#### $Ad_E$ process as a sequence of two kinetically separated steps

$E^+Y^-$ : ionic or strongly polarized reagents,  
 $Y^-$ : non-nucleophilic counterion,  
 $E^+$ ,  $Nu_{ext}$ : independent variables

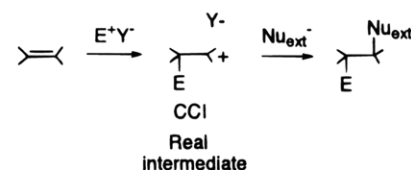

Obvious considerations suggested that such a reaction course might be feasible, at least in principle, provided the cationoid reagents of the type  $E^+ Y^-$  (where  $Y^-$  is a nonnucleophilic counterion, e.g.  $BF_4^-$ ,  $SbF_6^-$ , etc.) are employed, instead of conventional weakly polarized E-Nu reagents, and the reaction is carried out in nonnucleophilic solvents. Owing to the pioneering studies of G. Olah's group, the required reagents became easily available from the appropriate covalent precursors via a number of routes.<sup>5a</sup> Initial studies of the same group revealed that these cationoid reagents generated under superacid conditions are very reactive toward unsaturated com-

Scheme 3

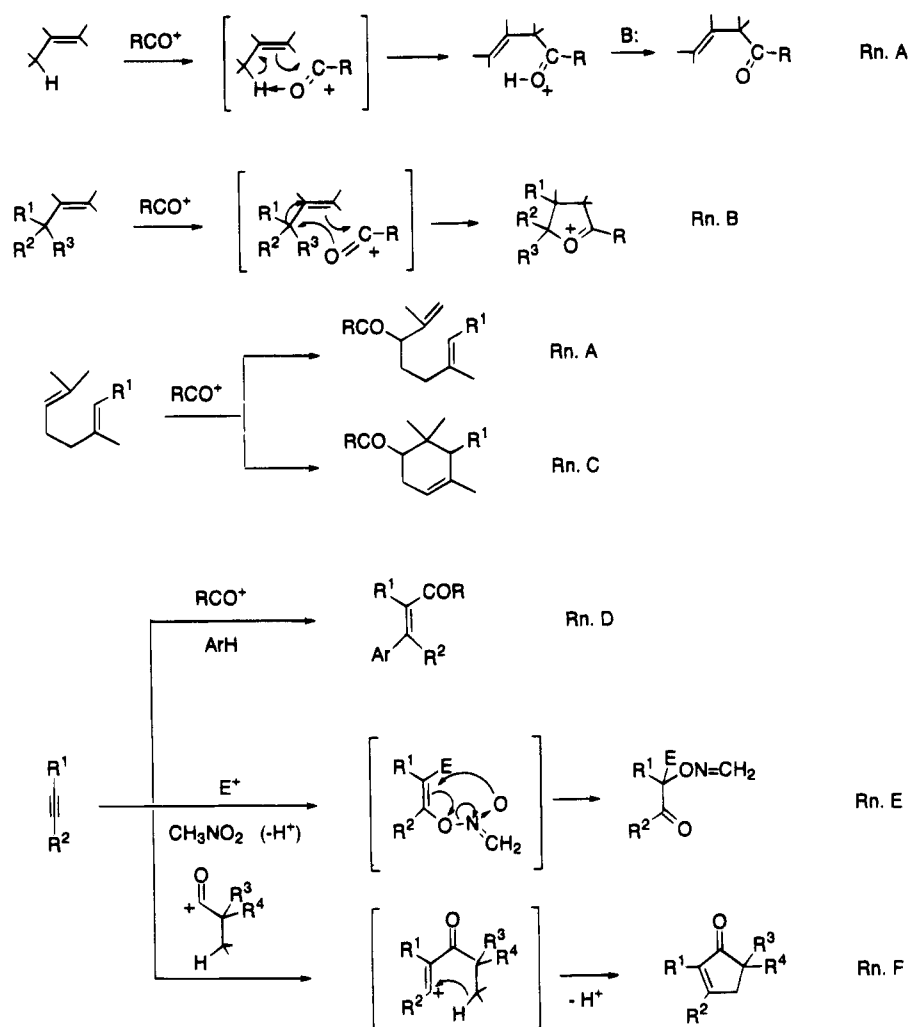

pounds but the most common result of their addition across the double bond is cationic oligomerization.<sup>5b</sup> The formation of CCl as a discreet species, namely the cyclic bromonium ion,<sup>5c</sup> was observed only for a rather particular case of the  $\text{Br}^+$  electrophile.

Further studies revealed that cationoid reagents can also be used in  $\text{Ad}_E$  reactions performed under more conventional conditions and might lead to the formation of 1:1 adducts with a complete exclusion of oligomerization.<sup>2,6a-c</sup> However the net outcome of these reactions with reagents like stabilized alkyl cations, acylium, or nitronium ions, clearly indicated that even under these, presumably optimal conditions, the CCl's, if ever formed, are too "hot" to exist as kinetically stable entities. Therefore it proved to be impossible to achieve a stepwise 1,2-addition of these electrophiles and external nucleophiles added to the reaction mixture as potential quenchers. The structure of the final products unambiguously indicated that an initial electrophilic attack at the double or triple bond was immediately followed by (or better to say, occurred simultaneously with) the processes like capture of halide from the respective counterion,<sup>6b</sup> eliminations,<sup>7a,b</sup> cyclizations,<sup>7c,d</sup> rearrangements,<sup>7e,f</sup> hydride shifts,<sup>7g,h</sup> or interaction with the nucleophiles present in the media including molecules of the "nonnucleophilic" solvent.<sup>7i,j</sup> Several of the observed transformations are worthy of additional comments

in the context of this review since they clearly demonstrate some peculiarities of  $\text{Ad}_E$  reactions with cationoid reagents as compared to their less polar counterparts and/or are of obvious preparative value. A set of representative examples is shown in Scheme 3.

Reaction A represents a general method for the preparation of  $\beta,\gamma$ -enones.<sup>7a,b</sup> Unlike its Darzen-Kondakov prototype, this reaction yields nearly pure products almost uncontaminated by  $\alpha,\beta$ -isomers. Reaction B was shown to proceed smoothly with preparative yields for a wide set of alkenes containing branching at the allylic carbon atom.<sup>7e,f</sup> Data of low-temperature NMR studies revealed that reaction A is best described by an ene-like mechanism, while the most plausible mechanism of reaction B involves an acylium ion attack at the double bond with a concerted 1,2-shift of hydride, methyl group, or Wagner-Merwein rearrangement, depending on the structure of the unsaturated substrate. Interaction of acylium ions with 1,5-dienes<sup>7c,d</sup> was shown to proceed alternatively either similarly to reaction A yielding acyclic enones or as a concerted acylation-cyclization sequence (reaction C). The control over the course of the reaction can be easily exerted by variations in the electrophilicity of the acylating species (cf. also data in ref 6c). Addition of acylium ions across the triple bond always proceeds as a concerted addition.

## Scheme 4

## Case A. Electrophiles capable of bridging

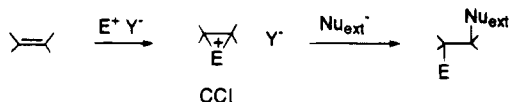

## Case B. Substrates containing cation stabilizing groups

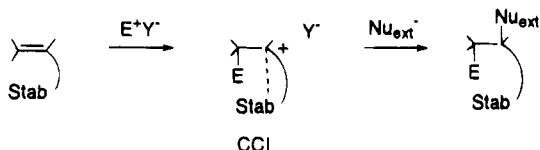

Thus the *trans*-acylation reaction (reaction D) takes place even in the presence of weakly nucleophilic aromatic solvents such as chlorobenzene.<sup>7i</sup> It was also surprising to find that nitroalkanes are sufficiently nucleophilic to participate in all the studied reactions of alkynes with various cationoid electrophiles (reaction E).<sup>7j</sup> The utilization of  $\text{CH}_2\text{Cl}_2$  as a solvent in an alkyne acylation resulted in either the formation of  $\beta$ -chlorovinyl ketones due to the involvement of the solvent as a source of nucleophile or the products arising from intramolecular addition. The latter process can even involve the participation of C–H bonds at the appropriately positioned  $\text{sp}^3$  center as nucleophiles, leading to the formation of the products of cyclization (e.g. reaction F)<sup>7g</sup> and/or 1,5-hydride shift.<sup>7h</sup>

These and similar data refer to the reactions which were carried out with *performed cationoid electrophiles* under conditions which might have been considered as *nonnucleophilic* by generally accepted standards. Thus these reactions may serve as adequate models revealing an intrinsic reactivity pattern for the cationoid species presumably formed as transient intermediates. A peculiarity, or even uniqueness, of the observed reaction modes might be considered as strong evidence against the viability of the traditional mechanisms which routinely suggest the involvement of cationic intermediates in numerous conventional  $\text{Ad}_E$  reactions performed under conditions much less favorable for the formation of ionized species. In other words, Sir R. Robinson's reservations quoted above are actually well-based and supported by a plethora of factual data.

The failure of attempts to observe the formation of cationoid intermediates as stable species in the course of the above-mentioned  $\text{Ad}_E$  reactions (e.g. Scheme 3) clearly indicated that the utilization of cationoid electrophiles represents only a *necessary but not a sufficient prerequisite for the realization of a two-step mode of  $\text{Ad}_E$  reaction*. Thus it became obvious that the survival of CCI's under ordinary (i.e. not under superacid!) conditions of preparative chemistry might be secured only if some additional structural factors are operative in order to stabilize these intrinsically unstable species.

Two limiting options were available to reach this goal (Scheme 4) and both were tested in our studies.<sup>2,8</sup>

*Case A.* The formation of a stabilized CCI might become feasible if the attacking electrophile bears a lone electron pair and thus is capable of participation in charge delocalization via formation of a bridged (onium) species.

*Case B.* Stabilization of CCI can be greatly enhanced provided the starting unsaturated substrate contains some fragment with a well pronounced propensity to stabilize the carbocationic center formed upon the addition at the adjacent double bond.

The ramifications and limitations of both of these options are considered below.

### III. Two-Step $\text{Ad}_E$ Reaction Based on the Use of Electrophiles Capable of Forming Bridged Carbocationic Intermediates (Case A)

The formation of bridged intermediates has been inferred from extensive data on the kinetics and stereochemistry of classical  $\text{Ad}_E$  reactions with the use of conventional covalent reagents containing heteroatomic electrophiles ( $\text{E}_{\text{het}}^+$ ) like halogens, alkyl- and arylsulfenyl (or selenyl) halides, or mercury salts.<sup>3a,b</sup> There are a number of preparatively useful cyclizations which are described as an initial addition of  $\text{E}_{\text{het}}^+$  across the double bond followed by an intramolecular trapping of the proposed bridged intermediates by some nucleophilic group present in the starting compound.<sup>9a-c</sup> However, in all these cases the reactions were targeted at the addition of the external E and internal Nu (second double bond or heteroatomic substituent of the substrates) across the reacting double bond. Hence there was no special necessity to channel the reaction via a truly ionic route (with the use of ionic instead of the traditional covalent reagents) which might have secured the formation of the corresponding CCI as a kinetically independent species.

Our studies aimed at the realization of a stepwise  $\text{Ad}_E$  process were carried out with cationoid sulfur-containing electrophiles, mainly  $\text{ArS}^+\text{BF}_4^-$  (generated *in situ* from  $\text{ArSCl}$  and  $\text{AgBF}_4$ ). It was discovered that the interaction of these reagents with a model alkene, cyclohexene **1**, proceeded in a long sought after way, namely via the formation of the bridged CCI (episulfonium ion, ESI) which turned out to be sufficiently stable in solution under ordinary (i.e. non-superacid) conditions to last until it was quenched with external nucleophiles. As a result of this sequence the corresponding 1,2-adducts **2a–h** were prepared in good yields<sup>10a</sup> (Scheme 5). In other

## Scheme 5

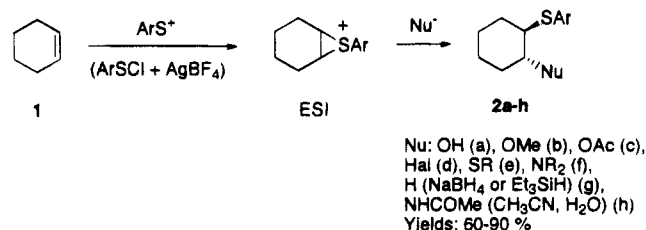

words, here we were able to observe for the first time a *truly stepwise  $\text{Ad}_E$  reaction which proceeded as a sequence of the two kinetically independent events*, namely (i) attack of the given electrophile,  $\text{ArS}^+$

## Scheme 6

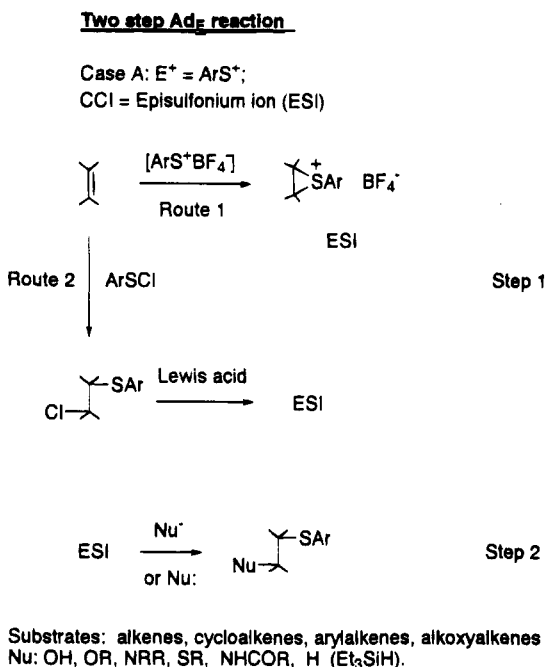

across the  $\pi$ -bond system and (ii) interaction of the cationoid intermediate thus formed with an arbitrarily chosen nucleophile.

The reaction mode exemplified for **1** turned out to be fairly general with regard to the variations in the nature of both alkene and nucleophile. In fact similar results were observed for acyclic alkenes with various substitution patterns (mono-, di-, or trisubstituted),<sup>10b-e</sup> arylalkenes,<sup>10e</sup> or 1,3-dienes.<sup>10f</sup> In several cases generated ESI intermediates were fully characterized by NMR spectra.<sup>10e,g,h</sup> The list of the quenchers included a set of standard inorganic and organic nucleophilic reagents, and thus a unified protocol was elaborated for the transformation of various alkenes into a wide array of  $\beta$ -substituted sulfides with an almost unlimited diversity in the substituents (e.g. **2a-h**) and in preparatively acceptable yields (generally 60–90%). These results generalized in Scheme 6 actually represent experimental proof of the validity of the suggested option formulated above as case A to the solution of the problem of the two step Ad<sub>E</sub> reaction.

A well-known classical Ad<sub>E</sub> reaction of covalent ArS-Cl has been traditionally described in terms of the intermediate formation of ESI.<sup>3a,b,10i</sup> However the above-mentioned experimental data on the reactivity of the preformed ESI necessitated a revision of this mechanism. Thus, as was shown experimentally, ESI can be easily trapped by various nucleophiles to give the respective 1,2-adducts (see Scheme 5). At the same time it is also known that the addition of the covalent ArS-Cl under conditions of moderate polarity leads to a nearly exclusive formation of the respective 1-chloro-2-arylthio adducts and solvoadducts are not formed even if the reaction is carried out in the nucleophilic solvents like acetic acid or acetonitrile. The disclosed discrepancy led to the conclusion that an ionic mechanism is not operative in this classical reaction and its intermediate is better described by the bridged but covalent  $\sigma$ -sulfurane structure.<sup>10j</sup> This suggestion is also consistent with

the observation that while the interaction of the covalent ArS-Cl with alkenes with *tert*-butylethylene is not accompanied by a 1,2-methyl shift, the latter rearrangement proceeds easily if the reaction is channeled via an ionic pathway by the utilization of ArS<sup>+</sup>-like electrophiles.<sup>10k,l</sup>

Several features of the elaborated two-step reaction are worthy of special comments. First of all, it must be emphasized that prior to our studies it was generally believed that, owing to the positive charge localization at the sulfur atom of ESI's, these cationic intermediates should be susceptible to nucleophilic attack directed mainly at the sulfur atom, the net result being the formation of ArSNu product and the regeneration of the starting alkene.<sup>10i,m</sup> If this were really the case, the elaborated two-step sequence would be totally meaningless from the synthetic point of view. Fortunately it turned out that, *as a rule, attack of nucleophiles is directed at the bridged carbon atoms*<sup>10j</sup> except for the case of sterically hindered ESI's like those derived from adamantylideneadamantane.<sup>10n</sup> Secondly, in all cases the net steric outcome of the process corresponds to the *trans*-stereospecific addition across the double bond<sup>10a,d,o</sup> (see Scheme 5 and the schemes below). Thirdly, the addition of ArS-electrophile and Nu to unsymmetrical alkenes produces *predominantly or even exclusively the Markovnikov (M) adducts*,<sup>10b,c,e</sup> arising from the attack of the Nu at the more substituted carbon atom of the ESI bridge.

The *trans*-stereospecificity of ESI ring opening is an expected result and is consistent with the generally assumed S<sub>N</sub>2-like reactivity pattern of the bridged intermediates.<sup>10i</sup> At the same time the observed predominance of the M-adduct formation seems to be rather peculiar, since *anti*-M regioselectivity is usually observed for the conventional ArS-Cl additions to unsymmetrical alkenes.<sup>10i</sup> Moreover, earlier MNDO calculations of the structure of a wide set of bridged species with structures ranging from pure  $\pi$ -complexes to "classical" three-membered rings led Dewar to the conclusion that since ESI undoubtedly belongs to the latter category the regioselectivity of its ring opening should be mainly controlled by steric effects and hence the attack of Nu should occur predominantly at the less substituted center.<sup>10p</sup> An obvious discrepancy between this conclusion and above-mentioned experimental data about predominant Markovnikov-like pattern of reactivity of the stable ESI (see also Schemes 7 and 8) was resolved by later MDNO molecular orbital calculations of the reaction pathways and potential energy surfaces for nucleophilic attack on the ESI.<sup>10q</sup> It was shown that for the interaction of nucleophile with ESI derived from propene, the transition state (TS) leading to the formation of the M adduct is better represented by a quasi-carbenium ion-like structure with a partial bridging and this TS is actually more stable than an alternative one leading to the *anti*-M adduct. These results provide a consistent explanation for both the carbenium ion-like reactivity pattern of ESI and a high stereoselectivity of its ring opening.

The generation of ESI via an Ad<sub>E</sub> reaction with ArS<sup>+</sup> (route 1, Scheme 6) was supplemented by an indirect but preparatively more convenient procedure

## Scheme 7

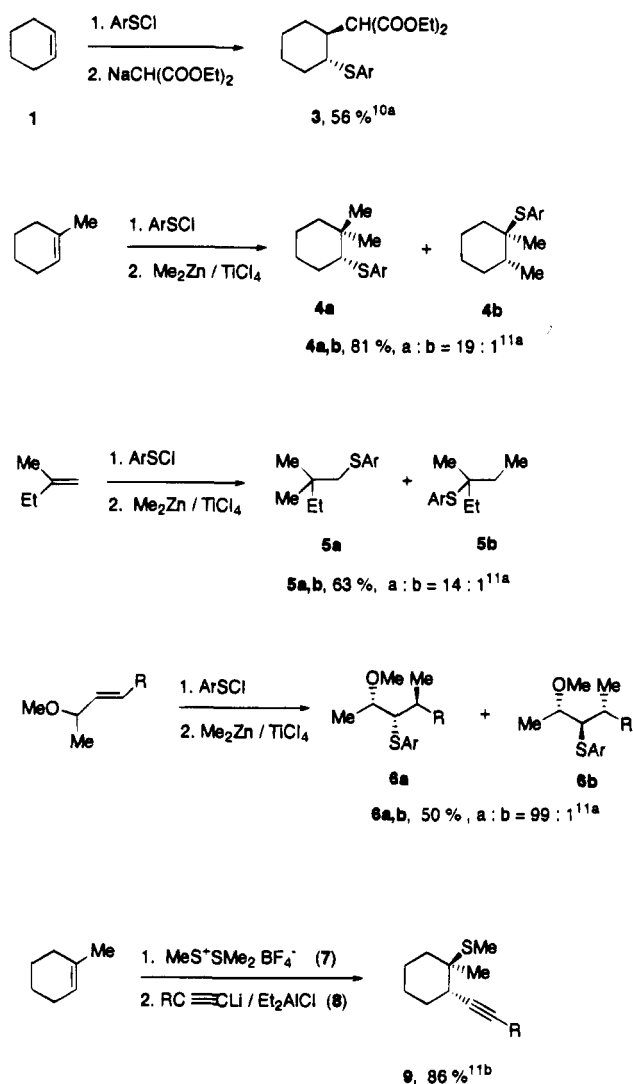

which involved the initial formation of  $\beta$ -(arythio)-alkyl halides (by the aforementioned  $\text{Ad}_{\text{E}}$  reaction of alkenes with covalent  $\text{ArSCI}$ <sup>10i</sup>) which were further treated with Lewis acids (LA)<sup>10j</sup> (route 2, Scheme 6). This procedure avoids generation of the unstable electrophilic species like  $\text{ArS}^+$  and is especially applicable when ESI-like intermediates are to be used *in situ*.

The disclosed carbenium ion-like reactivity pattern of ESI's suggested an appealing opportunity of their utilization as electrophiles in C–C bond-forming reactions with carbon nucleophiles ( $\text{Nu}_{\text{C}}$ ). This possibility was first checked for the stabilized carbanions like sodium malonates and, for example, adduct **3** was prepared from ESI derived from **1** (Scheme 7).<sup>10a</sup> As should have been expected, attempts to employ reagents like  $\text{RMgX}$  or  $\text{RLi}$  turned out to be fruitless, obviously due to the increased basicity of these nucleophiles (Smit, unpublished data). However later studies of Reetz's group<sup>11a</sup> disclosed that less basic alkyltitanium or alkylaluminum reagents could be used as  $\text{Nu}_{\text{C}}$  in ESI-mediated reactions. Thus the adducts like **4–6** were prepared in good yields with a high stereoselectivity and nearly exclusive Markovnikov regioselectivity from the respective alkenes. Here it is also relevant to mention that in related studies, Trost described alkynylsulfenylation at the

## Scheme 8

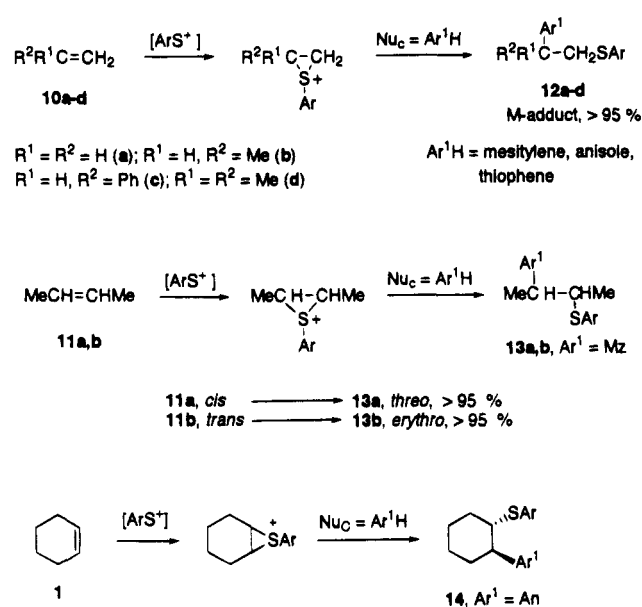

double bond carried out via treatment of the starting alkene with the (methylthio)dimethylsulfonium tetrafluoroborate (**7**) followed by the reaction of the resulting 1,2-adduct with a complex of lithium acetylide with diethylaluminum chloride (**8**). The formation of final products like **9**<sup>11b</sup> has also been described as proceeding via an ESI-like intermediate. However its exclusive *anti*-Markovnikov regioselectivity casts some doubts about the plausibility of this interpretation.

A much broader area of C–C bond-forming reactions evolved when  $\pi$ -donors were used as nucleophilic components. The viability of this approach was first shown for aromatic compounds.<sup>12a</sup> Thus ESI's derived from alkenes **10a–d**, **11a,b**, and **1** were found to react easily with activated aromatic or heteroaromatic compounds at low temperatures with the formation of the respective  $\beta$ -(arythio)alkylated adducts **12a–d**, **13a,b**, and **14** in preparatively acceptable yields (60–80%)<sup>12b</sup> (Scheme 8). The exclusive formation of Markovnikov adducts (e.g. **12b–d**) combined together with an unprecedented stereospecificity of this Friedel–Crafts-like process<sup>12c</sup> (e.g. formation of individual **13a** or **13b** from the respective **11a** or **11b** and **14** from **1**) attests to the peculiarities of ESI-mediated alkylation reactions. It is also noteworthy that this process can be effectively carried out in the presence of hindered amines and thus is applicable to acid-sensitive compounds.<sup>12a</sup>

Further studies revealed that in fact a variety of other  $\pi$ -donors like trimethylsilyl (TMS) vinyl ethers,<sup>12c–g</sup> ketene acetals,<sup>12h</sup> or allylsilanes<sup>12h–j</sup> can also react as  $\text{Nu}_{\text{C}}$  with ESI's with the formation of a C–C bond in accordance with the general equation shown in Scheme 9. A set of representative examples also given in this scheme was chosen to illustrate some novel synthetic opportunities offered due to the broad scope and high regio- and stereoselectivity of this reaction in conjunction with a variability of both the olefinic component (e.g. **10d**, **11a,b**, **15–18**) utilized for the generation of ESI and respective  $\pi$ -donors used as carbon nucleophiles (e.g. **19–26**).

## Scheme 9

## General reaction:

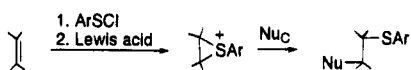

Nu<sub>C</sub> = TMS vinyl ethers, TMS ketene acetals, TMS allylsilane

Nu = C(R<sup>1</sup>R<sup>2</sup>)COR<sup>3</sup>, C(R<sup>1</sup>R<sup>2</sup>)COOR<sup>3</sup>, CH<sub>2</sub>-CH=CH<sub>2</sub>

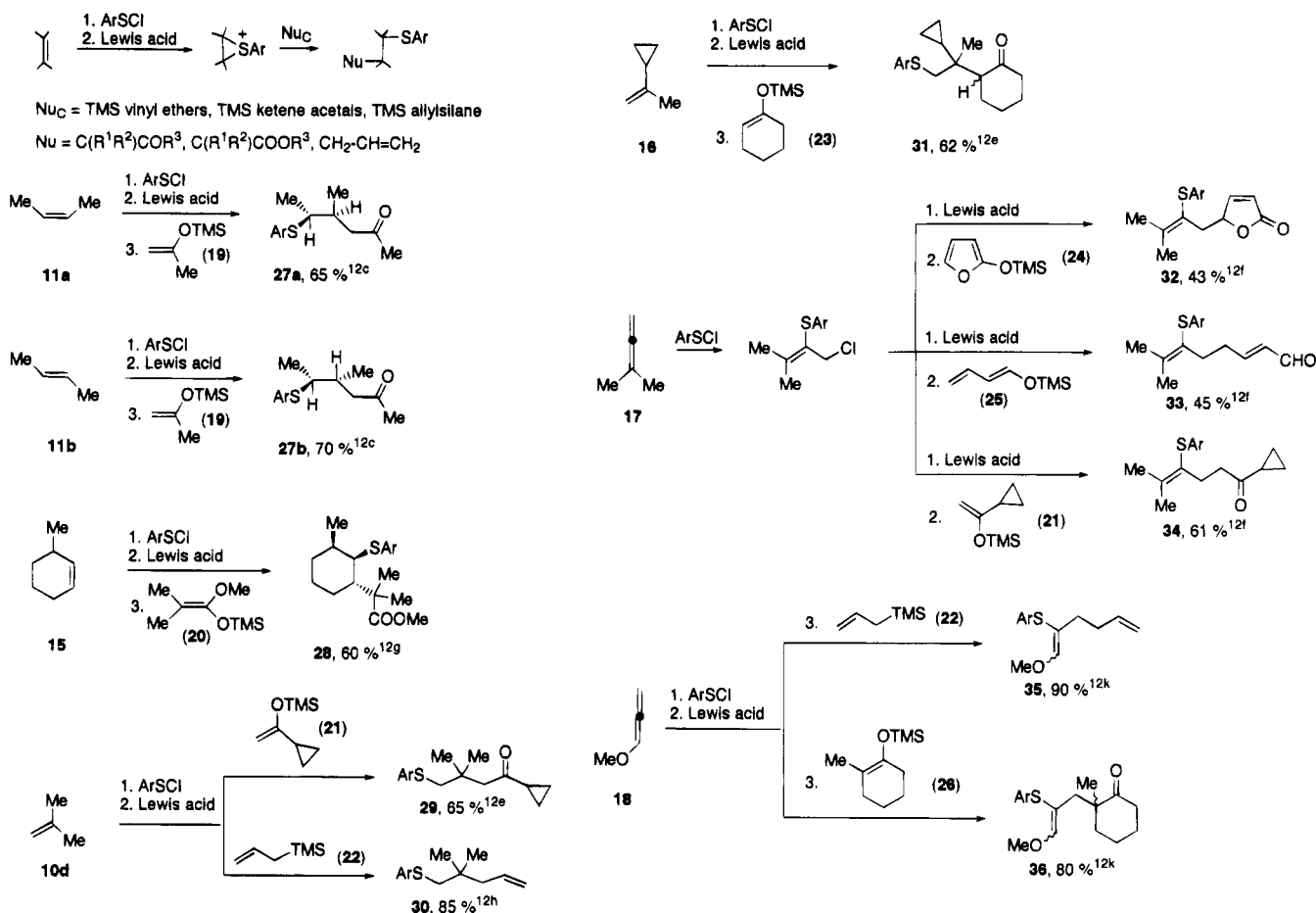

Thus the stereospecific preparation of **27a** and **27b** may serve as an example showing the unprecedented potential of the described ArS-mediated A<sub>D</sub>E reaction as a novel tool for the stereocontrolled synthesis in an acyclic series. The net steric outcome of the reaction might also be affected by the presence of remote substituents as is shown by the preparation of the single diastereomer **28** from **15**. (See also formation of a nearly pure stereoisomer of adduct **6** in Scheme 7.) The opportunity to prepare adducts bearing multiple functionalities as in **29**–**36** adds one more dimension to the synthetic potential of the discovered coupling. It is also noteworthy that the transformation of 1,1-dimethylallene (**17**) into adducts **32**–**34** represents an efficient route for a selective prenylation (after Raney Ni desulfurization) of the carbonyl component used for the generation of the TMS enol ether. At the same time the presence of the vinyl sulfide moiety in these adducts offers additional opportunities for their further synthetic utilization, e.g. via an oxidation followed by a double-bond shift and a sulfoxide–sulfenate rearrangement.

Utilization of vinyl ethers as alkene components for ESI generation with TMS enol ethers used as Nu<sub>C</sub> has led to the elaboration of a novel option of the crossed-aldol-like reaction.<sup>12k</sup> This reaction was shown to be applicable for all four possible combinations of “carbonyl” (vinyl ethers, e.g. **37**–**39**) and “methylene” (TMS enol ethers, e.g. **19**, **23**, **25**, **40**, **41**) components. Thus a wide series of  $\gamma$ -(arylsulfonio)- $\beta$ -alkoxy-substi-

tuted carbonyl compounds, e.g. **42**–**47** can be prepared as shown in Scheme 10.

While the described reaction invariably proceeds with *trans*-stereospecificity with regard to the addition at the double bond of the starting vinyl ether (e.g. **39**), its steric course at the newly created chiral center depends critically both on the nature of the components and reaction conditions.<sup>12k</sup> Thus, the *threo*:*erythro* ratio for the adduct **44** may vary from 1:4 (TiCl<sub>4</sub>, 20 °C) to 4:1 (ZnCl<sub>2</sub>, 20 °C). Likewise the reaction of **38** with **40** in the presence of TMSOTf gives predominantly the *erythro* isomer of **45** (*threo*:*erythro* = 1:8). At the same time, under essentially the same conditions, the reaction between **37** and **40** proceeds with little if any selectivity and adduct **42** is formed as a 1:1 mixture. Adduct **43** formed in the presence of TMSOTf contains at least 80% of a single 2,6-*trans* isomer (configuration at the quaternary center unknown). These observations indicate that with a proper choice of conditions a significant degree of diastereoselectivity might be secured. It is also obvious that additional studies are required in order to identify the factors affecting the stereochemical outcome of these couplings.

In the reactions described in Schemes 7–10, ESI's are actually employed as *synthetic equivalents of  $\beta$ -arylsulfonio-substituted carbenium ions and the net outcome of the sequence corresponds to the regio- and stereoselective (or even specific) ArS-mediated coupling of alkenes with various  $\pi$ -donors*. Since the nature of both starting alkene and carbon nucleophile

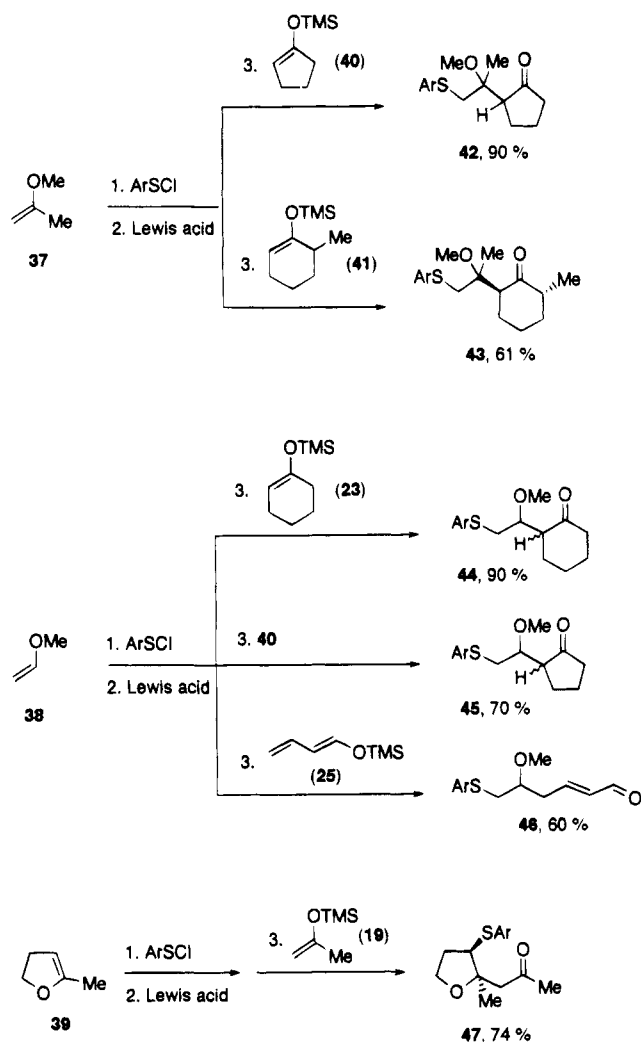

Scheme 10<sup>12k</sup>

can be varied independently and over broad limits the described reaction seems to represent a flexible and effective synthetic protocol.

Additional and rather unexpected ramifications emerged when vinyl ethers (VE) were employed not only as alkene components (VE-I) for the generation of ESI's but also as  $\text{Nu}_C$  (VE-II, see Scheme 11) to be alkylated with these electrophiles. Somewhat surprising, these reactions occurred smoothly<sup>13a-d</sup> without complications due to oligomerization of VE's, a common problem encountered in  $\text{Ad}_E$  reactions of these substrates with carbon electrophiles.<sup>13e</sup> Various combinations of vinyl ethers, e.g. **18**, **37**, **38**, **48**–**51** can be used as either component (VE-I or VE-II) and as a result 1:1 adducts like **52**–**56** were obtained in good yields after the standard quenching of the reaction mixture with water (Scheme 11). It was also found that ethoxyacetylene (**57**)<sup>13a</sup> may also serve as a  $\text{Nu}_C$  and in this case  $\gamma$ -substituted  $\alpha,\beta$ -unsaturated esters like **58** can be prepared (obviously as a result of  $\beta$ -methoxy group elimination from the initially formed adduct).

The generality of the coupling exemplified in Scheme 11 makes it an attractive version of the crossed aldol condensation, complementary to that described above in Scheme 10.

Eventually it was discovered that the utilization of this reaction offers also some unsuspected and

preparatively significant "fringe benefits". The complete absence of oligomerization in the course of the described  $\text{ArSCI}$  mediated VE's couplings led us to the conclusion that the immediate result of the ESI interaction with VE-II should be the formation of the next stabilized CCI, tentatively ascribed to the structure of the five-membered thiophanium salt (TPS, see below). Unfortunately, all attempts to isolate and/or identify the presumed intermediate by spectral methods failed owing to its instability.<sup>13f</sup> However even in the absence of direct evidence the suggested TPS structure seems to be the most plausible, validated by the observation that the net outcome of any of the couplings shown in Scheme 11 may vary depending on nature of the final nucleophile used for the quenching of the reaction mixture. In fact carbonyl compounds, like **52**–**56**, were obtained upon the usual aqueous workup, while the corresponding acetals or ethers can be prepared if alcohols or hydride donors are used as quenchers.<sup>13a</sup> A representative example is given in Scheme 12.

Transformations exemplified in Scheme 12 clearly indicated that the initial stepwise  $\text{Ad}_E$  reaction with the first alkene (VE-I, e.g. **38**) might be extended to include the next stepwise addition to the second alkene (VE-II, e.g. **38**). Thus all four components sequentially involved into this one-pot formation of final adducts like **59**–**61** are amenable to independent variations.

This reaction mode suggested an obvious and intriguing synthetic implication provided that the list of the quenchers for TPS-like intermediates could be expanded to include carbon nucleophiles,  $\text{Nu}_C$ . Initially this option seemed to be elusive at best<sup>13g</sup> and in fact first attempts to achieve this goal were discouraging. Thus it was found that regular  $\pi$ -donors like TMS vinyl ethers or allyl silanes are rather unreactive toward the TPS-like complexes at low temperatures, while at 0 °C a complex mixtures of products were formed which contained only trace amounts of the desired adducts (GS–MS data, unpublished). At the same time, somewhat surprisingly but much to our satisfaction, it turned out that certain Grignard reagents can be used successfully as  $\text{Nu}_C$  at this step. Thus the reaction complex formed in the course of  $\text{ArSCI}$ -mediated coupling of **38** and **51** underwent a smooth reaction with allylmagnesium chloride **62** (Scheme 13)<sup>14a,b</sup> and gave the corresponding adduct **63** as mixture of diastereomers in a yield of 67%. In a similar way other pairs of vinyl ethers, like **38** + **38**, **37** + **38**, or **50** + **51** were transformed via steps (i) the formation of the respective TPS and (ii) reaction of the latter with Grignard reagents **64**–**67** into adducts **68**–**72** (yields 62–78%).

The reactions shown in Scheme 13 were carried out as a *one-pot four-component coupling resulting in the formation of two novel C–C bonds in accordance with the general equation*  $\text{ArS}^+ + \text{VE-I} + \text{VE-II} + \text{R}^-$ . Its viability is actually based on the sequential formation of two discrete cationoid intermediates, first the ESI and then the TPS (see schemes above). In this sequence, the initial electrophile  $\text{ArS}^+$  is employed



## Scheme 11

## Crossed aldol reaction via a general route\*:

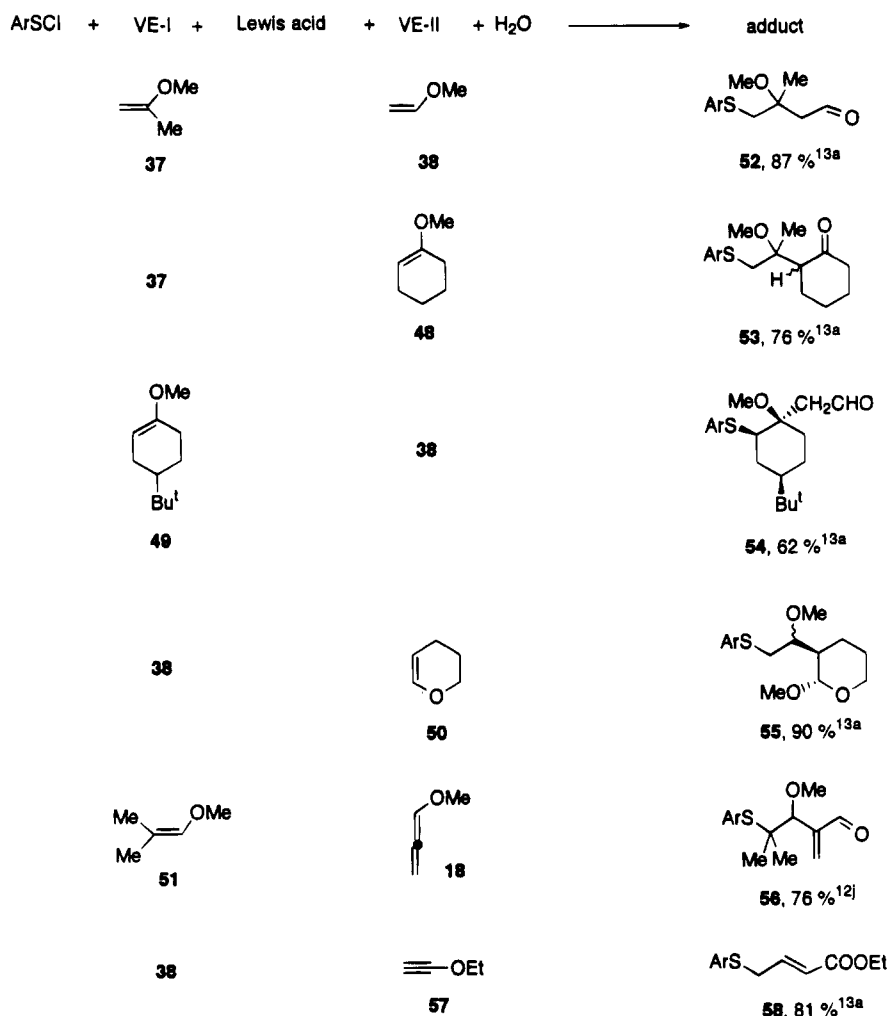
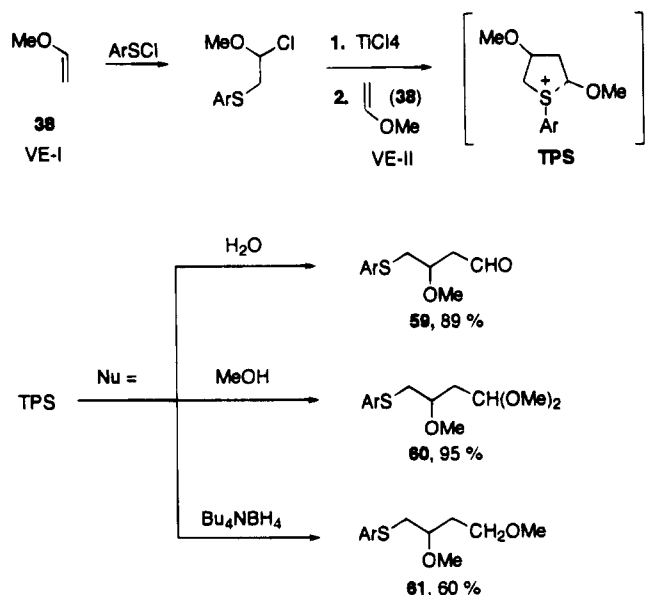
\* ArSCI = p-TolSCI; TiCl<sub>4</sub> was used as the Lewis acidScheme 12<sup>13a</sup>

as a sewing tool for the consecutive stitching of three nucleophilic fragments. The promise of this tandem coupling as a *convergent and flexible* protocol for the

assembly of polyfunctional molecules from simple precursors seems to be obvious.

The possibility of exerting rigorous stereocontrol is of primary importance for the evaluation of the true synthetic value of any multicomponent coupling. Data given in Scheme 13 indicated that the coupling of acyclic vinyl ethers in the presence of TiCl<sub>4</sub> followed by a reaction with Grignard reagents to give the adducts **63**, **68**, and **69** proceeds with a low selectivity. However it was also shown that the selectivity of adduct **63** formation can be increased up to the ratio **a:b** = 8:1 if AgBF<sub>4</sub> or BF<sub>3</sub>·Et<sub>2</sub>O are used as Lewis acids, while a slightly reversed selectivity was observed for TMSOTf (**a:b** = 3:4).<sup>14c</sup>

Variability in the stereochemical outcome was also observed for the cases when dihydropyran **50** was employed as a VE-I and **51** as a VE-II. Not surprisingly the initial addition at the double bond of **50** proceeded as a clean *trans* addition in all cases studied (cf. earlier data in Schemes 7–9). As for the diastereoselectivity of the later steps, it was found that a nearly complete stereospecificity at the C-2' center can be achieved when the reactions are performed in the presence of TiCl<sub>4</sub>. In fact, only a single diastereoisomer (from a possible four) was

Scheme 13<sup>14a,b</sup>

TPS-like species as electrophiles in the reactions  
with Grignard reagents as carbon nucleophiles, Nu<sub>c</sub>

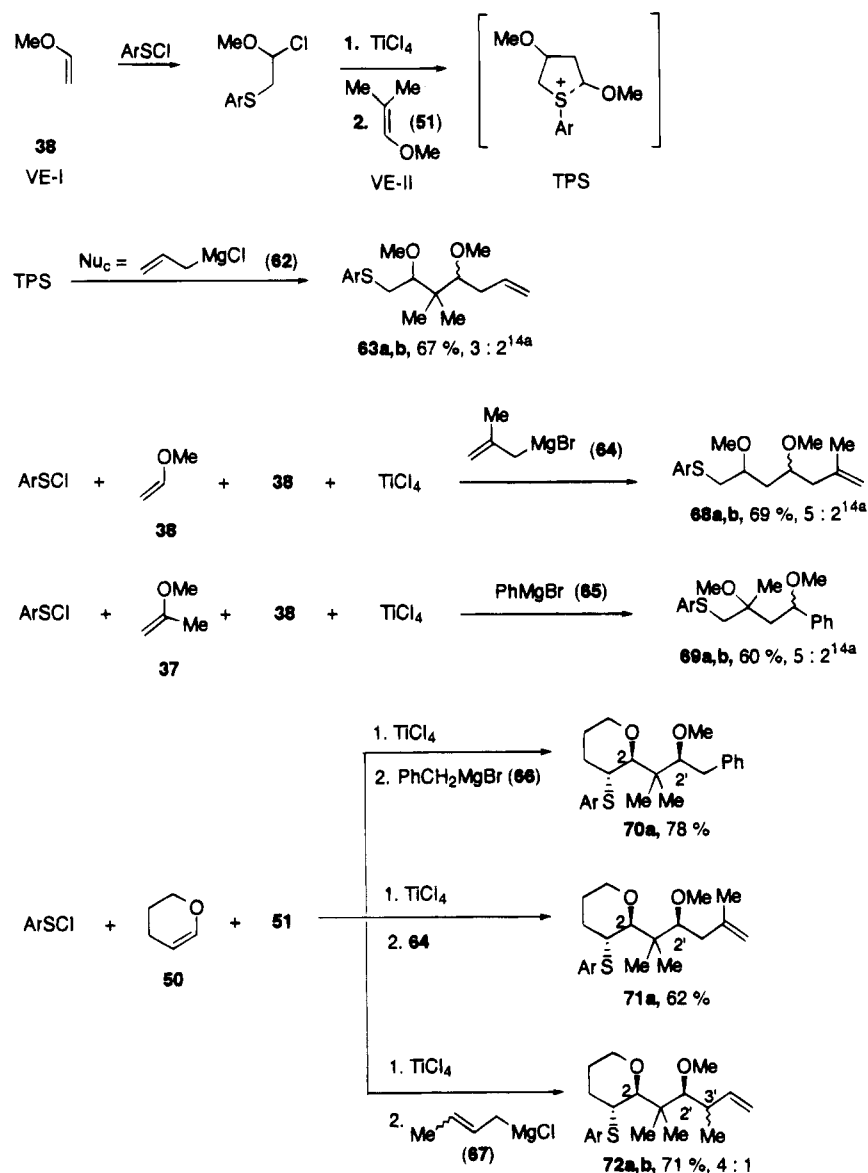

detected upon NMR analysis of the adducts like **70a** or **71a** obtained under these conditions.<sup>14c</sup> 2,3-Anti-2,2'-syn configuration of the substituents at C-2 and C-2' was established for **71a** by using X-ray crystallography. Adduct **72a,b** appeared as 4:1 mixture of diastereoisomers, having the identical configuration at C-2, C-3, and C-2' centers but differing in the configuration at C-3' of the side chain. This ratio is close to the *E/Z* ratio of the crotyl chloride used for the preparation of **67** and thus the formation of **72** might be also described as a stereoselective process at both newly created lateral centers, C-2' and C-3'. The use of other Lewis acids leads to a fairly different stereochemical pattern. Thus adduct **71** is formed as a 1:1 mixture of diastereoisomers at C-2' in the presence of SnCl<sub>4</sub>. A similar reaction with AgBF<sub>4</sub> yields preferentially the 2,3-anti-2,2'-anti isomer **71b** with a **a:b** ratio being dependent on the nature of the initial electrophile (**a:b** = 1:3 or 2:3 for Ar = *p*-MeC<sub>6</sub>H<sub>4</sub> or *p*-ClC<sub>6</sub>H<sub>4</sub> respectively).<sup>14b</sup> It is still premature to discuss the observed pattern of

diastereoselectivity and further studies of the reaction course with these substrates is certainly warranted, especially in view of the plethora of literature data attesting to the opportunity to control the steric outcome of related reactions by the proper choice of reaction parameters.<sup>14d</sup>

A summary of the above results generalized in Scheme 14, may serve as a good illustration of the novel synthetic opportunities which emerged owing to the realization of the stepwise Ad<sub>E</sub> reaction with electrophiles capable of forming stabilized bridged intermediates. The common step of the whole array of the conversions shown is actually the transformation of the starting alkene moiety into ESI (i.e., *umpohlung of nucleophilic alkenes into electrophilic species*), which is used further as a stabilized carbenium ion equivalent capable of preserving its steric integrity in reactions with various nucleophiles. The reaction shown at the bottom of this general scheme represents a rare, if not a unique, case of the tandem use of the two consecutive stepwise Ad<sub>E</sub> reactions,

## Scheme 14

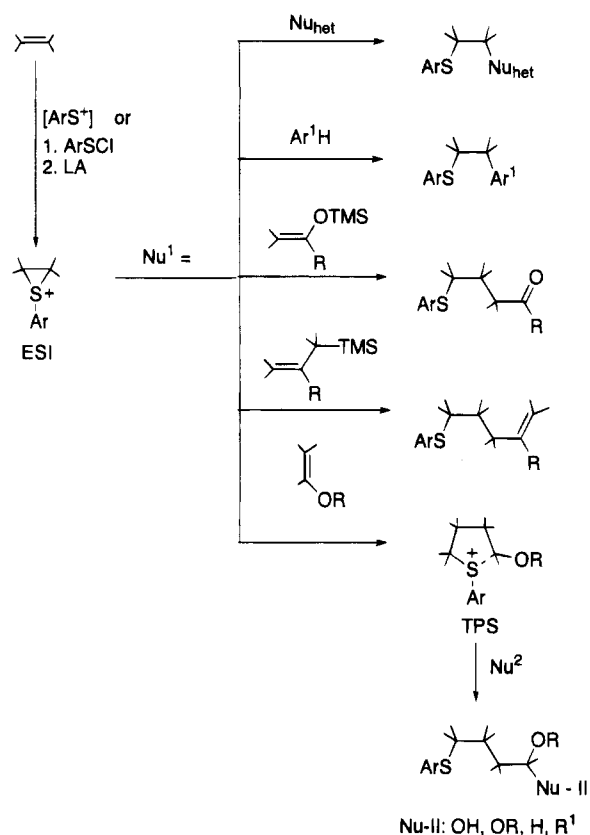
Synthetic potential of ArS-mediated Ad<sub>E</sub> reactions

which secures a controllable assemblage of polyfunctional molecules from simple precursors via a one-pot procedure.

As a conclusion to this section, it seems appropriate to consider some results of our continuing studies as illustrative of the immediate synthetic ramifications of the above-mentioned results. A well-pronounced diastereoselectivity typical of many of the reactions shown above suggested the possibility of their utilization in an enantioselective synthesis. One of the most obvious options envisaged the use of chiral unsaturated carbohydrates, glucals, as VE-I component. A readily available protected derivative, tri-*O*-benzyl-D-glucal **73** was chosen to check this option. Transformation of **73** into the corresponding ArSCI adduct **74** and the Lewis acid-promoted reaction of the latter with hydroxyl containing compounds is a well-documented procedure for the preparation of various *O*-glycosides.<sup>15a</sup> However prior to our studies no attempts were made to apply this sequence for the synthesis of *C*-glycosides. We have found that ESI **74a** generated from **74** (formed *in situ* from **73**) under the action of Lewis acids also is able to participate in C–C bond forming reaction with a set of nucleophiles, Nu<sub>C</sub>, like **20–25**, **65**, **75**, and **76** in a manner similar to that described above in Schemes 9 and 10. Thus adducts **77–85** were obtained in satisfactory or good yields (Scheme 15).<sup>15b</sup> It was also noted that in the case of active nucleophiles such as PhMgBr **65** the presence of the Lewis acid is unnecessary and the adduct **83** is formed directly from the glucal–ArSCI adduct **74**.

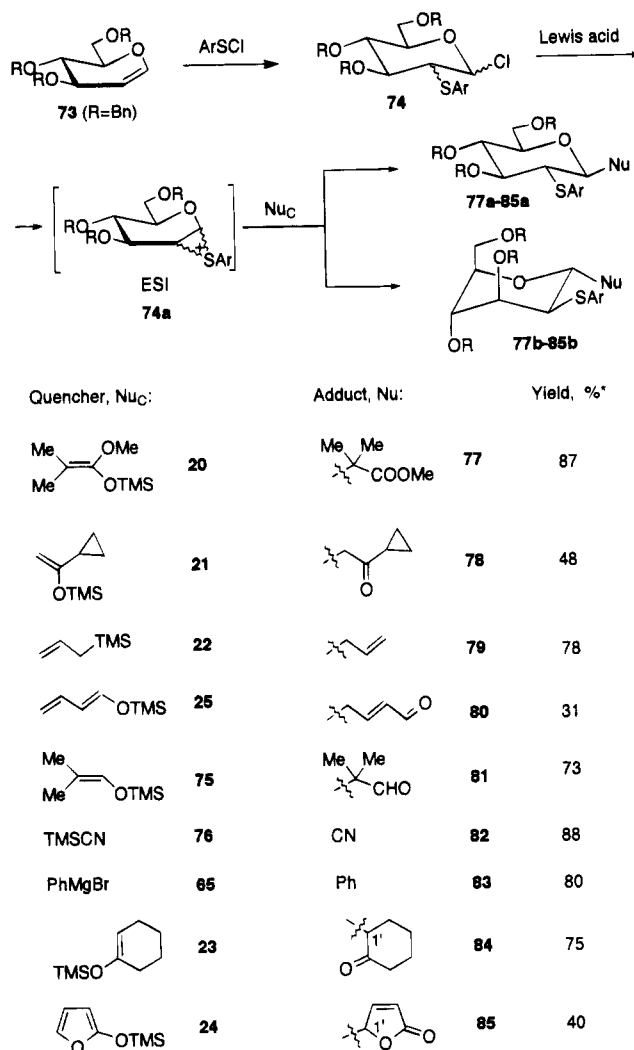
Scheme 15<sup>15b,c</sup>

\* Yields refer to the experiments in CH<sub>2</sub>Cl<sub>2</sub> with Ar = *p*-Tol and SnCl<sub>4</sub> as Lewis acid except for **83** where no LA was required.

Generally the reaction proceeds with a preferential formation of β-D-gluco isomers **77a–85a**. The utilization of SnCl<sub>4</sub> as a Lewis acid and CH<sub>2</sub>Cl<sub>2</sub> as a solvent ensure a rather high diastereoselectivity (ratio **a:b** varies from 10:1 for **80–81** to 19:1 for **77–79** and **82–85**). It is noteworthy that the steric course of the reaction at the glycosidic center is sensitive to variations in the reaction conditions (Lewis acid, different Ar group in ArSCI, and solvent). Thus the mixture of nearly equal amounts of isomers **81a** and **81b** was formed when the reaction was carried out under the action of SnCl<sub>4</sub> in CH<sub>3</sub>NO<sub>2</sub>. It was especially rewarding to learn that the reaction may exhibit a remarkable stereofacial selectivity as is evidenced by a highly predominant formation of one diastereomer (more than 85% of the mixture) at the newly created chiral center C-1' of the adducts **84a** and **85a**.<sup>15c</sup>

The utilization of vinyl ethers, e.g. **51** or **38**, as nucleophiles in the reactions with ESI **74a** led to much the same results as were discussed above for the simpler models (Scheme 12 and 13). Here again a tandem sequence of two consecutive stepwise additions turned to be a viable option as is shown in Scheme 16. In fact it was found that the Lewis acid-

Scheme 16

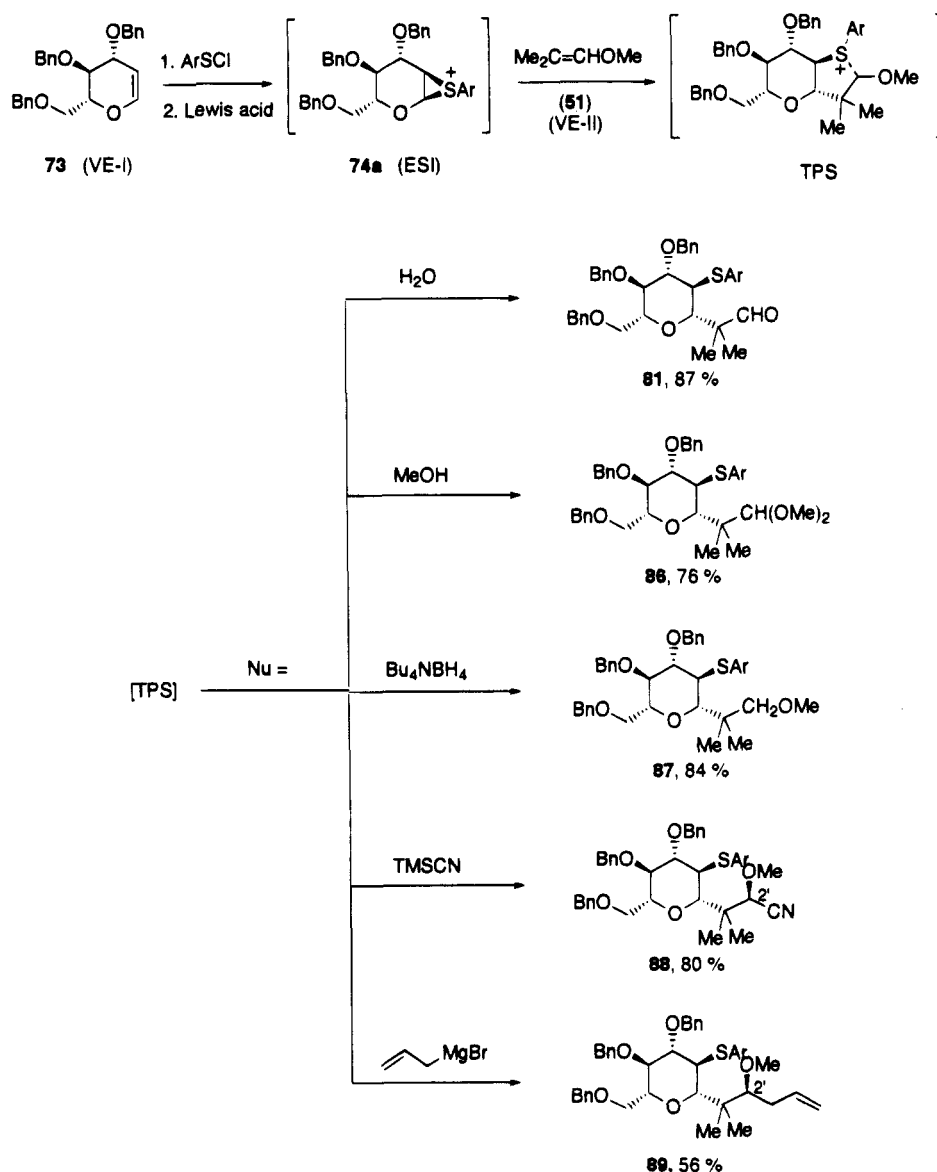

mediated interaction of vinyl ether **51** with **74a** may lead to the formation of any of the adducts **81** and **86–89** depending on the nature of the nucleophile used for the quenching of the reaction mixture.

Remarkably, the adducts **88** and **89** were shown to be formed as nearly individual stereoisomers. Hence the described four-component coupling led to the creation of three novel chiral centers with a rigorous control of stereochemistry exerted at all elementary steps. Of special preparative significance is the disclosed opportunity to achieve an efficient 1,3-stereocontrol as is evidenced by a high selectivity of the formation of a newly created chiral center at C-2' of the side chain of **88** and **89**.

Elucidation of the scope and optimization of the reaction variables for the described stepwise  $\text{Ad}_E$  reactions with chiral precursors like glucal derivatives is under active study in our laboratories since this approach might offer a new and most flexible options for a stereoselective one-pot preparation of the diverse carbohydrate derivatives bearing multifunctionalized substituents at the C-1 center and additional chiral center(s) in the side chain. These

derivatives are of obvious value as advanced intermediates in the total synthesis, especially for the preparation of various C-glycosides, a newly emerging class of biologically active analogs of natural compounds with a promising pattern of physiological activity.<sup>15e</sup>

#### IV. Two-Step $\text{Ad}_E$ Reaction with Unsaturated Substrates Containing an Adjacent Cation Stabilizing Group (Case B)

Stabilization of a carbenium center secured by the presence of various adjacent groups is a general and well-known phenomena.<sup>5a</sup> Quite a number of these groups could have been chosen to serve our purposes. However among various possible candidates,  $\mu$ -alkyne-dicobalt hexacarbonyl complexes seemed to be especially suitable for the following reasons: (i) dicobalt hexacarbonyl (DCHC) complexes are formed easily regardless of the structure of the acetylenic derivatives and the latter are easily recovered from these complexes; (ii) a triple bond protected as a DCHC complex is strongly deactivated toward conventional

## Scheme 17

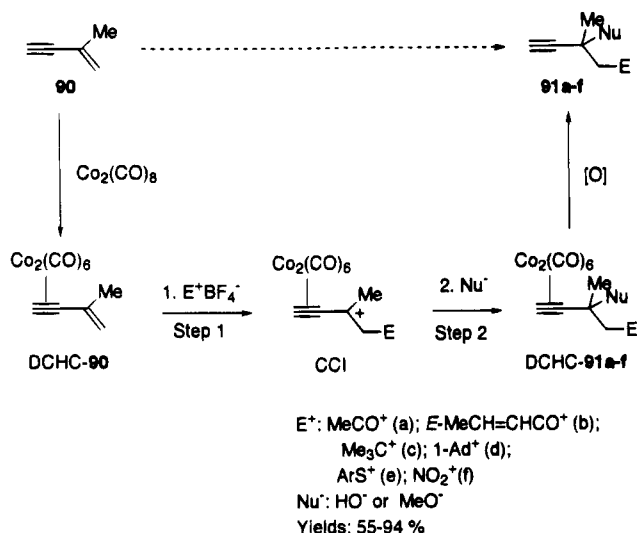
Two step  $Ad_E$  reaction. Case B.

electrophilic reagents; and (iii) the  $\mu$ -alkyne DCHC complex reveals a powerful stabilizing effect at the adjacent (propargylic) carbenium ion center.<sup>16</sup> It was equally important that the model substrates for the planned study, namely 1,3-enynes, can be easily prepared from almost any carbonyl compound, containing at least one  $\alpha$ -hydrogen (many 1,3-enynes are also commercially available).

At the beginning of our studies it was uncertain whether DCHC complexes of conjugated enynes would be (i) stable enough to tolerate the attack of the strong (cationic!) electrophiles and (ii) capable of stabilizing variously substituted carbocationic intermediates (CCI's) which should be formed upon the addition of a various electrophiles across the double bond. Trial experiments performed with the DCHC complex of isopropenylacetylene **90** showed that the answer is "yes" to both these issues (Scheme 17).<sup>17a</sup>

In fact it was found that such different electrophiles as carbenium, acylium, nitronium, or arylsulfonium tetrafluoroborates add readily at the double bond of the DCHC-**90** without affecting the protected triple bond and giving the corresponding substituted propargylium CCI's. The latter proved to be reasonably stable (at least for several hours within the temperature range  $-70$  to  $-20$  °C) and can be quenched further with external nucleophiles like  $H_2O$  or  $MeOH$ . The overall result of this process corresponds to the independent addition of electrophile and nucleophile at the double bond of the starting enyne leading to the regioselective formation of the 1,2-adducts DCHC-**91a-f**. The latter can be nearly quantitatively decomplexed into the respective compounds **91a-f** under the action of mild oxidants.<sup>17a</sup> It is noteworthy that in fact this was the first example of a true and fairly general *stepwise  $Ad_E$  reaction with regard to variation of both the electrophilic and nucleophilic components*.

In much the same way, DCHC complexes of other acyclic and cyclic 1,3-enynes with a different pattern of substitution can be used as substrates in this reaction.<sup>17b-f</sup> The variety of structures amenable for preparation by this route will be shown below.

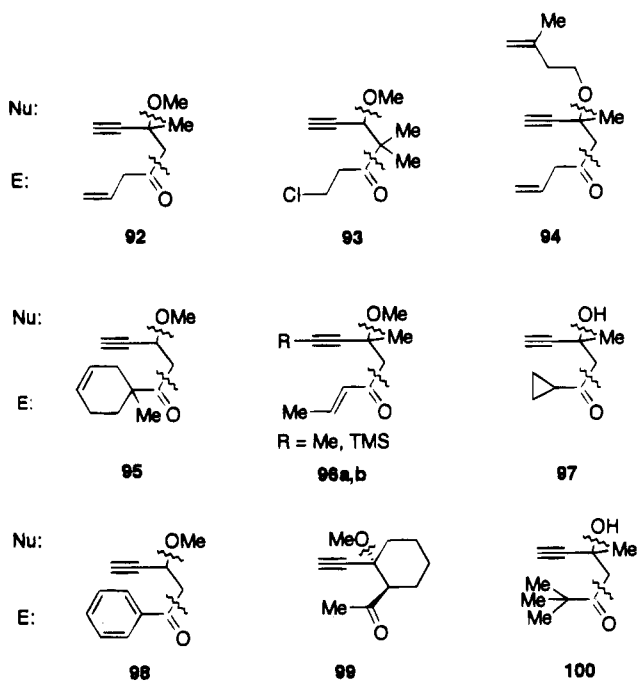
Scheme 18<sup>17b,e,f</sup>

Yields: 63-94 %

Among electrophiles capable of participating in this addition, acylium electrophiles proved to be the most versatile reagents due to the ease of preparation and handling of these species belonging to various structural types. Hydroxy- or alkoxyacylation of the double bond of DCHC complexed conjugated enynes was elaborated into a reliable preparative method.<sup>17f</sup> An almost unlimited diversity in variations of the acyl residue can be illustrated by the selection of examples of methoxy (hydroxy) adducts **92-100**<sup>17b,e,f</sup> (Scheme 18) prepared from the respective 1,3-enynes with the help of the sequential procedure shown above in Scheme 17. In fact, as can be seen from these data, the presence of such moieties as double bonds, both conjugated or unconjugated, easily removable  $\beta$ -substituents, aromatic and small rings, or sterically demanding substituents does not affect substantially the effectiveness of the described reaction.

In particular, the elaborated protocol was shown to be useful as a short pathway leading to the  $C_5 + C_5$  assemblage of a  $C_{10}$  framework of regular monoterpenes. Thus reaction of **90** with  $C_5$  acylium cations **101** or **102** followed either by water quenching or proton abstraction led to the formation of adducts **103-105** that could be easily transformed (by a partial hydrogenation of the triple bond) into tagetanol, tageton, or ocimenone, respectively (Scheme 19).<sup>17b</sup>

As was shown in Scheme 17, a stepwise addition also can be achieved with stabilized carbenium ion electrophiles like *tert*-butyl or 1-adamantyl tetrafluoroborates (adducts **91c,d**). From the preparative point of view by far more important is the demonstrated opportunity to utilize functionalized carbenium ion derivatives such as the DCHC-complexed propargylium ion salt **106**<sup>17b</sup> or the  $\alpha$ -arylthio-substituted carbocationic reagent **107**<sup>17g</sup> which secured the preparation of polyfunctional compounds **108a,b** or **109** correspondingly (Scheme 20).

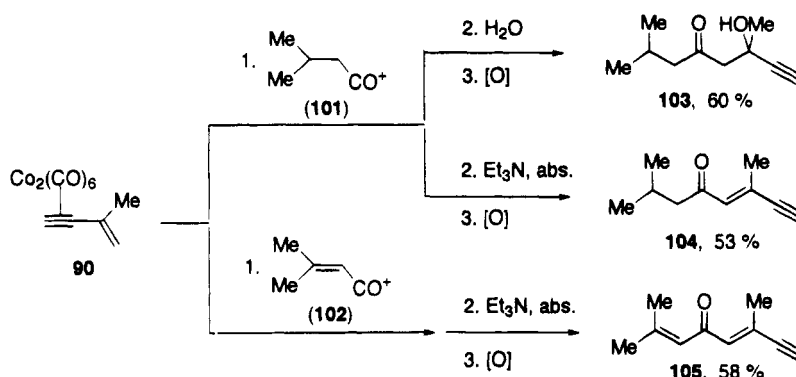
Scheme 19<sup>17b</sup>

## Scheme 20

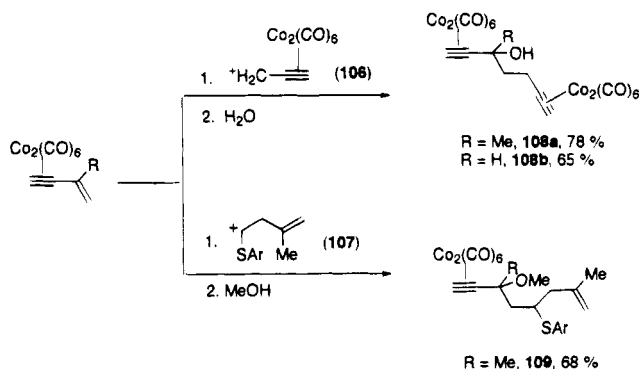

As was established in the studies of Nicholas' group, DHC complexed primary, secondary, or

## Scheme 21

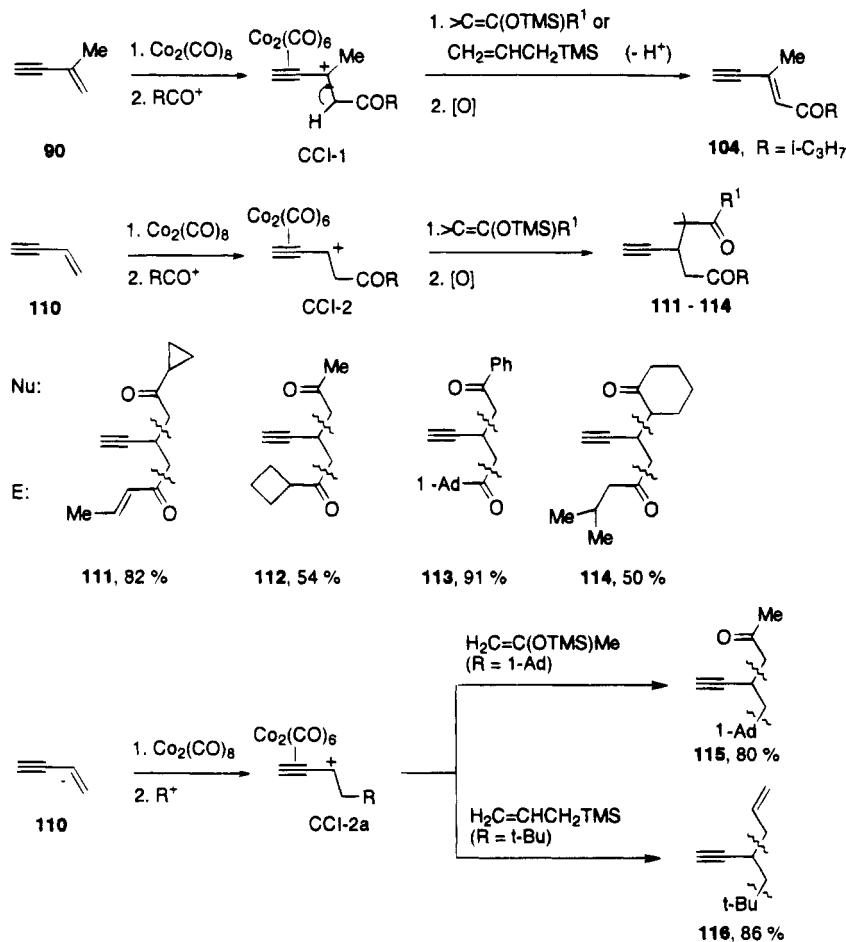

tertiary propargylic cations are able to alkylate various carbon nucleophiles, including TMS enol ethers or allylsilanes.<sup>16</sup> To our dismay, initial attempts to quench tertiary CCI-1 formed upon the addition of acylium ion to DHCC-90 (Scheme 17) with TMS enol ethers as  $\text{Nu}_\text{C}$  failed. No reaction was observed at low temperatures while a temperature increase led to the formation of the corresponding conjugated enone, e.g. **104**, obviously due to the ease of proton abstraction from the  $\alpha$ -carbonyl atom of the CCI (Scheme 21). However the same reaction when tried for CCI-2 produced by acylium ion addition to the disubstituted double bond as in DHCC-110 worked without any complications and resulted in the formation of various 1,5-diketones<sup>17c,d</sup> (e.g. **111**–**114**, Scheme 21).

## Scheme 22

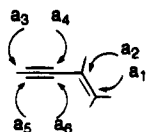
1,3-Enynes as potential equivalents of hexadentate synthons

$a_1 = E$ ;  $a_2 = Nu$  for a stepwise  $Ad_E$  reaction

The selection of examples given illustrates the versatility of the elaborated reaction sequence as a method providing an opportunity to prepare diverse 1,5-diketones with an unsymmetrical pattern of substitution which is predetermined by the choice of appropriate  $E$  and  $Nuc$ .<sup>17d</sup> The product thus formed also contains an ethynyl group at C-3, an additional functionality of obvious synthetic value.

Formation of the adducts **115** and **116** was also achieved as a result of the two step addition with alkyl carbenium ions (1-adamantyl or *tert*-butyl) used as the electrophile and (trimethylallyl)silane or 2-(trimethylsiloxy)propene as nucleophiles respectively.<sup>17d</sup>

In the examples shown in Scheme 21 *two novel C–C bonds were formed as the result of a one-pot stepwise  $Ad_E$  process with independent variations in the nature of both addends*, a result which has never been observed before in any of the plethora of other  $Ad_E$  reactions (cf. data for conjugated  $Ad_N$  reactions leading formally to the same results in ref 1a).

The course of addition across the double bond of conjugated enynes exemplified in the schemes above deserves some additional comments. It is well known that conventional  $Ad_E$  reactions in this series usually occurred in a nonselective way since the conjugated system tends to react as a whole entity. Thus for all practical purposes no general and preparative method was known which was suitable for the selective addition at the double bond of vinylacetylenes not affecting the triple bond.<sup>18</sup> The lack of such a method imposed a set of limitations on the options available, at least in principle, for the synthetic utilization of conjugated enynes as highly reactive and readily available starting materials.

In fact the exhaustive addition to the unsaturated bonds of the enyne system might lead to the formation of six novel  $\sigma$ -bonds as is shown in Scheme 22 and thus potentially *1,3-enynes could be considered as synthetic equivalents of hexadentate synthons*.

It is also obvious that the sequence given in Scheme 22 has no practical value in the absence of tools to exert a control over regio- and stereoselectivity of  $a_1$ – $a_6$  additions at all consecutive steps. The results considered above clearly demonstrated that the formation of the DCHC complex at the triple bond followed by a stepwise  $Ad_E$  reaction has actually solved the problem of a strictly regioselective addition of variety of addends  $a_1 = E^+$  and  $a_2 = Nu^-$  across the double bond of the starting enyne moiety. This successful debut actually opened an entry toward elaboration of the further steps which might lead eventually to the controlled and sequential utilization of the potential of the triple bond still present in the adducts.

The observed efficiency of stepwise additions with unsaturated electrophiles ( $E_{unsat}$ ) or unsaturated nucleophiles ( $Nu_{unsat}$ ) resulting in the formation of polyunsaturated adducts (e.g., **92** and **94–96**, Scheme 18) prompted the idea of utilization of the latter as substrates for intramolecular cyclizations involving both the intact triple bond and a newly introduced double bond. In this respect the intramolecular Pauson–Khand (IMPK) cyclization, a cobalt carbonyl-mediated yne–ene–carbonyl [2 + 2 + 1] cycloaddition,<sup>19</sup> seemed to be an especially appealing choice because the required precursors, DCHC complexes of 1,6-enynes (or less often 1,7-enynes), can be prepared easily by a stepwise  $Ad_E$  pathway via either route 1 or 2 as shown in Scheme 23.<sup>8,17f,20a</sup>

The feasibility of the suggested approach was first checked for route 1. Various unsaturated alcohols like allyl, methylallyl,  $\alpha,\alpha$ -dimethylallyl or (*E*)-crotyl turned out to be equally efficient as  $Nu_{unsat}$  and thus a series of the respective adducts like **117–121** were prepared by alkenyloxyacylation of various enynes (e.g. **90**, **110**, **122**, or **123**) as shown in Scheme 24. These adducts were utilized further as substrates for the IMPK cyclization. As a result of these two consecutive reactions a set of bi- or tricyclic compounds, e.g. **124–128**, containing the 3-oxabicyclo-[3.3.0]octanone moiety plus additional functionalities was readily prepared from simple precursors in an acceptable overall yields.<sup>20a,b</sup>

It is noteworthy that the initial attempts to achieve cyclization of these substrates under conventional conditions of the IMPK reaction, i.e. by the thermolysis in a hydrocarbon solution<sup>20c</sup> led to rather frustrating results, since only trace amounts of the cyclized products were formed. This failure was obviously due to the presence of thermolabile  $\beta$ -alkoxy substituent in **117–121**. After many fruitless attempts to improve this procedure a rather unusual solution was found owing to some accidental observations. It turned out that the required reaction can be carried out under much milder conditions if the substrate undergoes thermolysis while being applied to the surface of a chromatography adsorbent in the absence of any solvents.<sup>20a,b,d–f</sup> While the reasons for the observed rate enhancement of this reaction under these adsorption promoted conditions (APC) remain obscure (the same refers to many other reported cases of cycloadditions under APC), their utilization turned out to be very critical for the labile polyfunctional substrates assembled by the  $Ad_E$  approach.

The alternative route for the preparation of substrates for the IMPK reaction involves the utilization of  $\alpha,\beta$ -unsaturated (or their synthetic equivalents,  $\beta$ -chloroalkyl) acylium ions as electrophiles in the  $Ad_E$  reaction. The corresponding adducts, e.g. **129–132** (Scheme 25), are usually obtained in good or excellent yields.<sup>20a,g,h</sup> However, since the double bonds in these compounds are deactivated due to the presence of an electron-withdrawing group, there seemed to be no chance for their immediate use as substrates for the cyclization (cf. data in ref 19). In fact trial experiments to carry out the IMPK reaction directly with acylmethoxyadducts like **129** were rather unrewarding. At the same time simple functional group transformation like 1,2-hydride reduction or Grig-

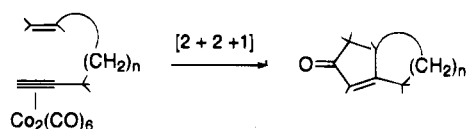
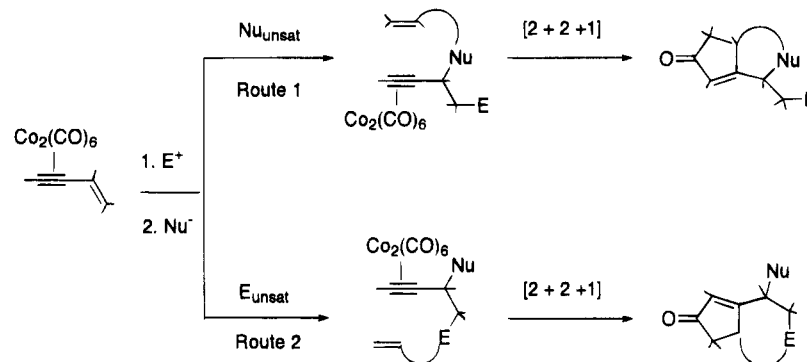

## Scheme 23

**Intramolecular Pauson-Khand reaction**<sup>19</sup>**Possible options for the transformation of 1,3-enynes into substrates for intramolecular Pauson-Khand reaction via a stepwise  $\text{Ad}_E$  route**<sup>20a</sup>Scheme 24<sup>20a,b</sup>**Route 1:**  $\text{Nu}_{\text{unsat}}$  = alkenyloxy group,  $\text{E}$  = acyl

## General scheme:

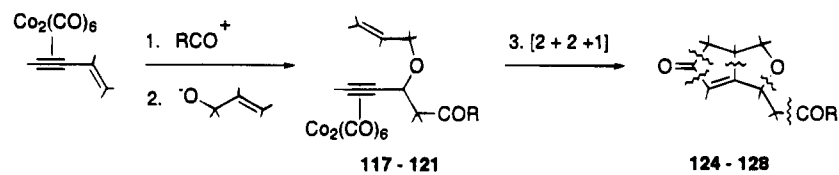

## Examples:

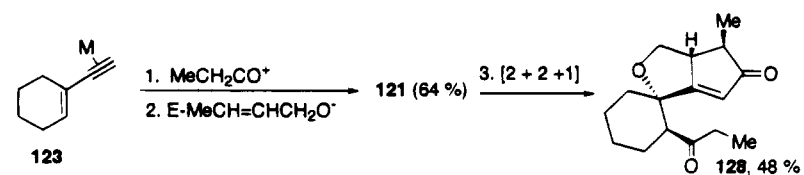
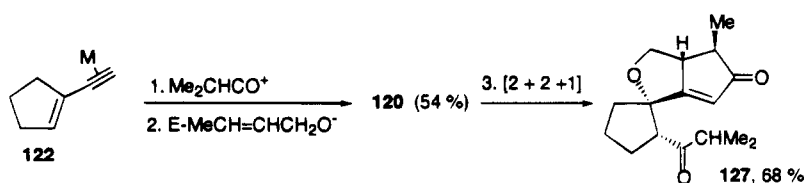
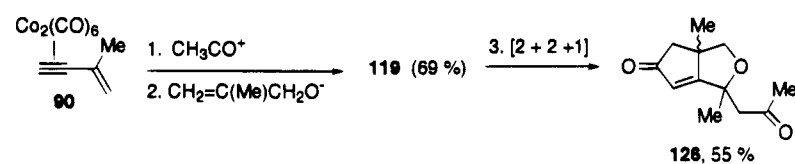
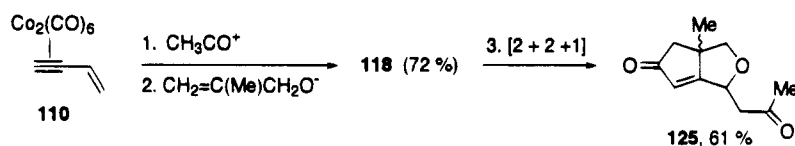
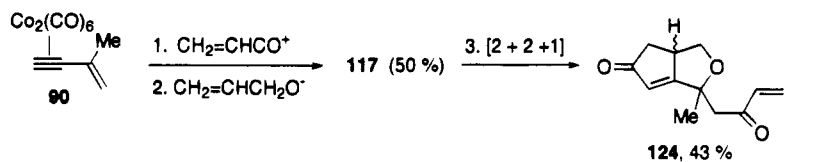

## Scheme 25

**Route 2:**  $E_{\text{unsat}} = \alpha, \beta$ -unsaturated acylium ions, Nu = methoxy group

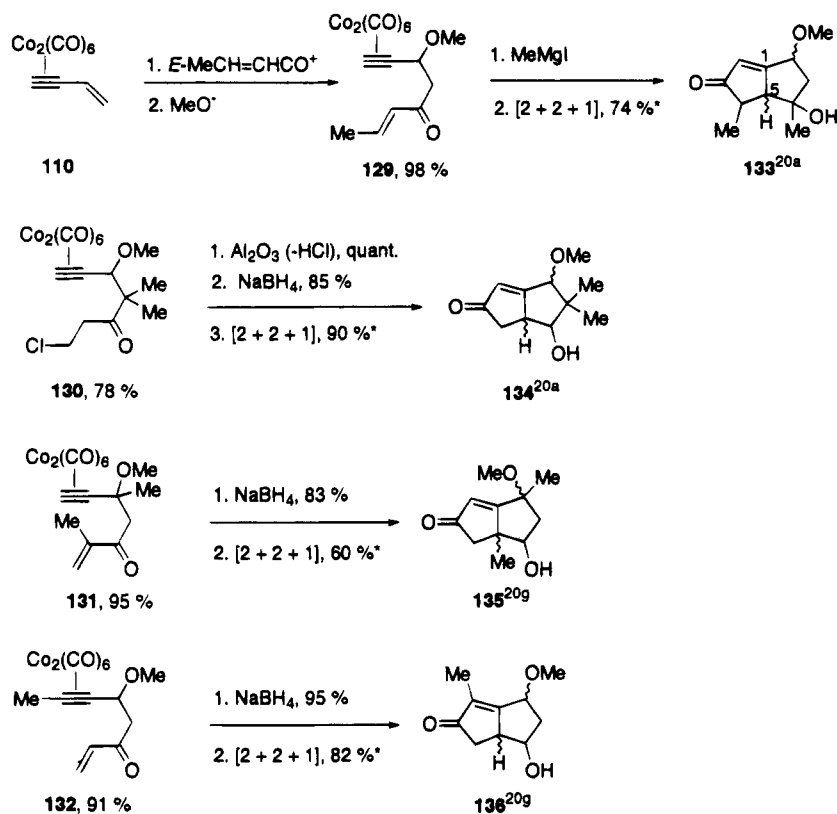

\*Yield refers to the cyclization of the major stereoisomer formed upon the  $\text{NaBH}_4$  reduction

nard addition (yields 80–95%) restored the reactivity of the double bond and the conversion of these transformed adducts into the corresponding bicyclic products **133–136** proceeded with a good efficiency (yields ca. 60–80%).<sup>20a,g,h</sup> It is noteworthy that in these cases the utilization of APC for the cyclization was also of crucial importance.<sup>20g</sup>

Transformation of the carbonyl group in **129–132** resulted in the formation of a mixture of diastereomeric alcohols which were easily separated by TLC. Cyclization of individual diastereoisomers revealed a noticeable stereoselectivity in the formation of bicyclooctenones **133–136** with a ratio of diastereoisomers at the newly created chiral center C-5 varying from 2:1 up to 6:1 depending on the substituent pattern and the stereochemistry of acyclic precursors. These data closely corroborate with those reported previously for the steric course of the IMPK reaction for related systems.<sup>19,20i</sup> No attempts were made to improve stereoselectivity on the model reactions shown in Scheme 25, albeit it is worthwhile to mention that the stereoselectivity of similar cyclizations can be dramatically enhanced by the introduction of auxiliary substituents, like  $\text{Me}_3\text{Si}$  at the triple bond and/or voluminous protecting groups at the hydroxyl center.<sup>19</sup> The bicyclic systems prepared by this simple route seem to be of obvious usefulness as advanced intermediates for the synthesis of various polyquinanes.<sup>21</sup> In particular adduct **134**, prepared in five steps from the available 4-methyl-3-hydroxy-1-pentyne in an overall yield of 40%

contains the A–B diquinane moiety with *gem*-dimethyl groups, which is a common fragment for a number of triquinanes of the hirsuten family. The presence of a set of functionalities makes **134** a suitable precursor for the construction of the missing C-ring.

The reaction sequences leading from the starting enynes to the final cyclic products as is shown in Schemes 24 and 25 are actually based on the *exhaustive use of the synthetic potential of the cobalt carbonyl moiety*. In fact the latter was initially utilized as a *protecting group* for a triple bond against electrophilic attack and as a group *stabilizing* the cationic intermediate formed upon the addition of electrophile at the double bond, while at a later step it did an excellent job as the *reacting partner* in the intramolecular cyclization. A net outcome of these consecutive reactions corresponds to a controlled addition of addends  $a_1$ – $a_4$  (Scheme 22) at the 1,3-enyne moiety and thus the latter is employed as an *equivalent of a tetradentate synthon*.

The versatility of the stepwise  $\text{Ad}_E$  approach for the assemblage of substrates for the Pauson–Khand cycloaddition secures an easy adaptation of the whole protocol for the synthesis of more complicated structures. Thus, the reaction of DCHC–**110** with an acylating reagent containing a cycloalkene unit like **137** gave the respective acylmethoxy adduct **138** in a nearly quantitative yield (Scheme 26). Hydride reduction of **138** yields **139** as a mixture of stereoisomers. Both isomers underwent Pauson–Khand

## Scheme 26

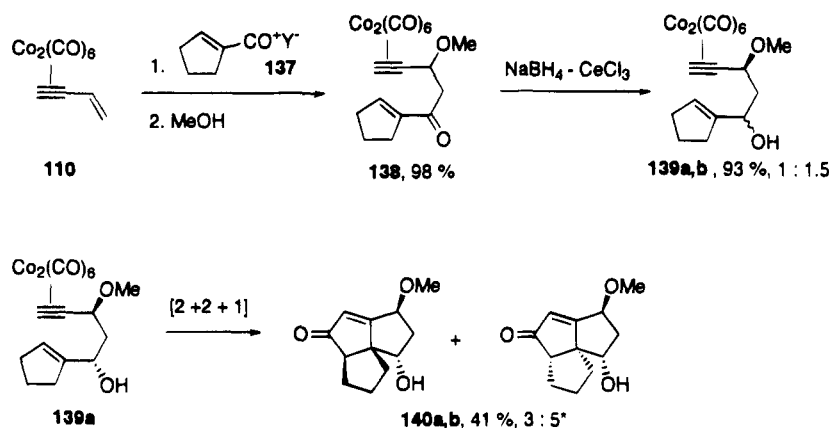

\* Cyclization of **139b** gave the respective pair of isomers **140c,d** having syn-positioned OH and OMe groups.

cyclization with the formation of the corresponding stereoisomers of angularly fused triquinanes **140**.<sup>22a,b</sup>

The simplicity and efficiency of the preparation of the precursor **139** look especially impressive if compared with the previously described rather laborious sequences (e.g. data in ref 22c,d) leading to the synthesis of related structures.

Alternatively the use of 1-ethynylcycloalkenes as the substrates opens the entry into the preparation of linearly fused tricyclics<sup>22a,b</sup> (Scheme 27).

Here the stereochemistry of the initial  $\text{Ad}_E$  reaction across the double bond is of special importance. As was established in our earlier studies,<sup>17e</sup> the methoxyacylation of **122** results in the formation of a mixture of easily separable *cis* and *trans* adducts in ratio of ca. 1:2 under kinetically controlled conditions. At the same time a nearly exclusive formation of the more stable *trans* adduct can be achieved under the conditions favoring an equilibration of the initially formed mixture. It was found that the geometry of either isomer is conducive to the Pauson–Khand cyclization. Thus a standard sequence of carbonyl reduction and IMPK reaction converted the *trans*-acylmethoxy adduct, **141**, or *cis*-acylmethoxy adduct, **142** (formed by acylation of **122** with crotonoyl or with methacryloyl tetrafluoroborates correspondingly), into the tricyclic compounds **143** or **144** with *cis*- and *trans*-fused A–B rings, respectively. Remarkably, in this series both the formation of reduction products **145** and **146** and their cyclization exhibited a rather high stereoselectivity.<sup>22b</sup>

It was hoped that the application of the same reaction sequence in the cyclopentene series would secure a direct entry into the preparation of linearly fused tricyclopentanoids related to natural products. Unfortunately it turned out the steric outcome of the  $\text{Ad}_E$  reaction for **123** is entirely different from that described for **122**. In fact, contrary to the above-mentioned data for the cyclohexane series, a nearly pure *cis* adduct **147** was formed as the most stable isomer upon the methoxyacylation of **123** followed by equilibration of the reactive mixture. It is well known that *trans*-fusion of cyclopentane rings is highly unfavorable and therefore it was not surprising to find that the *trans* configuration of ethynyl and

acyl substituents in **147** completely blocked the [2 + 2 + 1] pathway for this substrate. The required *trans* adduct **148** was prepared only as a 1:1 mixture with the *cis* adduct **147** under kinetically controlled conditions of methoxyacylation (yield 63%). This mixture was quantitatively reduced into the mixture of alcohols **149** and **150**. Under the conditions of Pauson–Khand reaction the latter isomer was smoothly converted into the desired triquinane **151a,b**, while the “wrong” isomer **149** was left intact. Albeit the yields of the reactions leading to the alcohols **149** and **150** were excellent and no isomer separation was required at the intermediate steps, the overall efficiency of **151a,b** formation never exceeded 30%.<sup>22b</sup>

While the sequences leading to the assemblage of bi- or tricyclic systems from simple precursors shown above were actually not very lengthy (usually only three steps were required), they suffer from the necessity to use an auxiliary operation, the carbonyl group modification. This step, besides being essentially nonconstructive, creates an additional chiral center and hence necessitates the separation of isomers, which can be rather troublesome. Fortunately recent data has shown that at least in some cases, all these complications can be eliminated.

In fact in the course of optimization of the procedure for the preparation of adduct **142** from **122** it was discovered (again accidentally!) that the product immediately formed at the acylation step can undergo cyclization without a prior modification of carbonyl group merely in the course of product isolation on alumina.<sup>22b,e</sup> In this case cyclization was accompanied by MeOH elimination and a partial hydration of the conjugated double bond. Both stereoisomers of **142** were equally effective in this reaction. As a result a mixture of tricyclic products **152a,b** was formed in a fair overall yield (Scheme 28).

Further studies indicated that this increased propensity to undergo IMPK cyclization is a typical property for the sterically rigid adducts containing  $\alpha$ - or  $\alpha$ - and  $\beta$ -substituents at the double bond. This peculiarity proved to be especially valuable for elaboration of a pathway leading to the formation of tetracyclic compounds from the precursors prepared

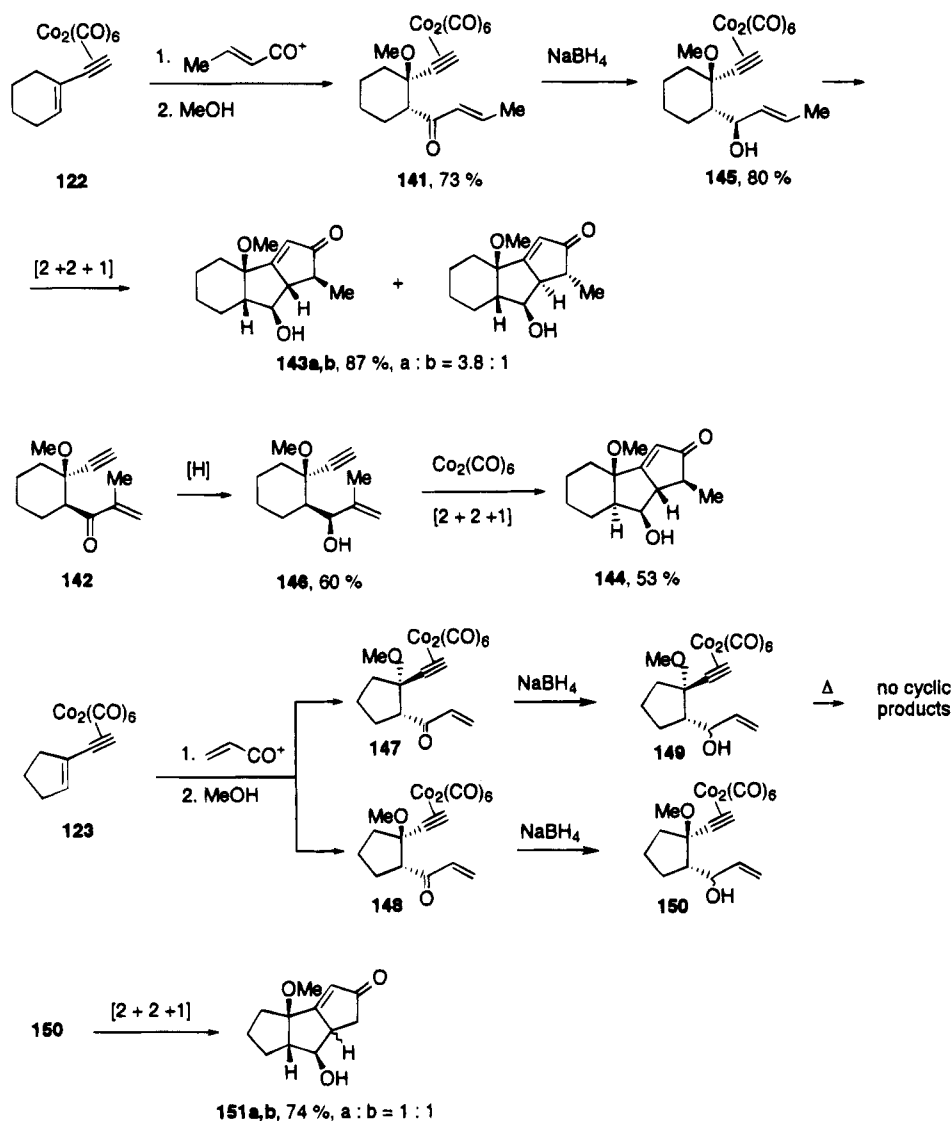
Scheme 27<sup>22b</sup>

via an interaction of cyclic enynes with cyclic acylating agents.<sup>22b</sup> In fact we have found that the acylmethoxy adduct **153** easily prepared from **122** and **137** underwent smooth transformation into the tetracycle **154**. Here again isomeric composition of initial mixture **153a,b** does not affect the cyclization course. In case of the adducts **155a,b**, formed in quantitative yield from **123** and **137**, only one isomer, **155a**, was amenable to the cyclization which proceeded without MeOH elimination (yield of **156** ca. 73%, calculated for the content of **155a** in the initial mixture). The isomer **155b** with the unfavorable *trans* configuration of ethynyl and acyl residues could be recovered from the mixture with **156** and recycled via an equilibration into the same mixture of isomers **155a,b**.<sup>22b,e</sup>

These results were obtained for model systems and the scope and limitations of these observations are still to be elucidated. Nevertheless they represent a good illustration of the synthetic power of a stepwise  $\text{Ad}_E$  reaction as a tool which provides an opportunity to elaborate a unique protocol involving only two operationally simple reactions for the preparation of tri- and tetracyclic compounds from available starting materials.

It is worthy of note that the tetracyclic ring system of **156** actually represents the basic A-B-C-D carbon framework of the natural tetraquinane crinipellin-B<sup>22f</sup> while adduct **154** contains a combination of rings identical to the B-C-D-E ring system of the pentacyclic terpene retigeranic acid.<sup>22g</sup> The data mentioned above suggest a new strategy for the synthesis of these and related compounds based on a tandem use of the stepwise  $\text{Ad}_E$  plus IMPK reactions as the key steps for the convergent buildup of the complex polycyclic frameworks furnished with additional functionalities required for the further elaboration toward target structures. This approach is currently under active study in our group.

In search of novel opportunities for the synthetic use of  $\text{Ad}_E$  adducts, a stepwise addition was carried out with acylium ions, containing the  $\alpha,\beta$ -,  $\gamma,\delta$ -diene system. It was rewarding to find out that the presence of the latter moiety does not interfere with the reaction and methoxyacylation of DCHC-**90** with sorbinoyl or furylacryloyl tetrafluoroborates (**157** and **158**, respectively) proceeds uneventfully to give the expected products **159** and **160** in excellent yields (Scheme 29). Thus far the attempts to carry out intramolecular Diels-Alder (IMDA) reaction with

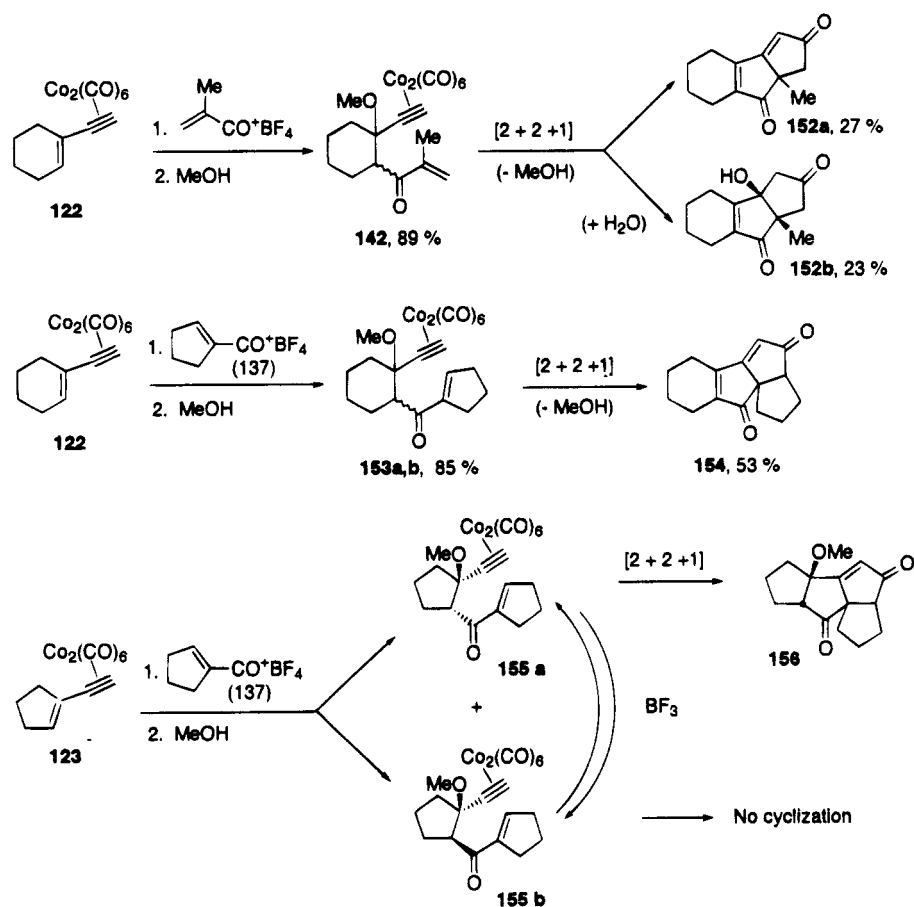
Scheme 28<sup>22b,e</sup>

Scheme 29

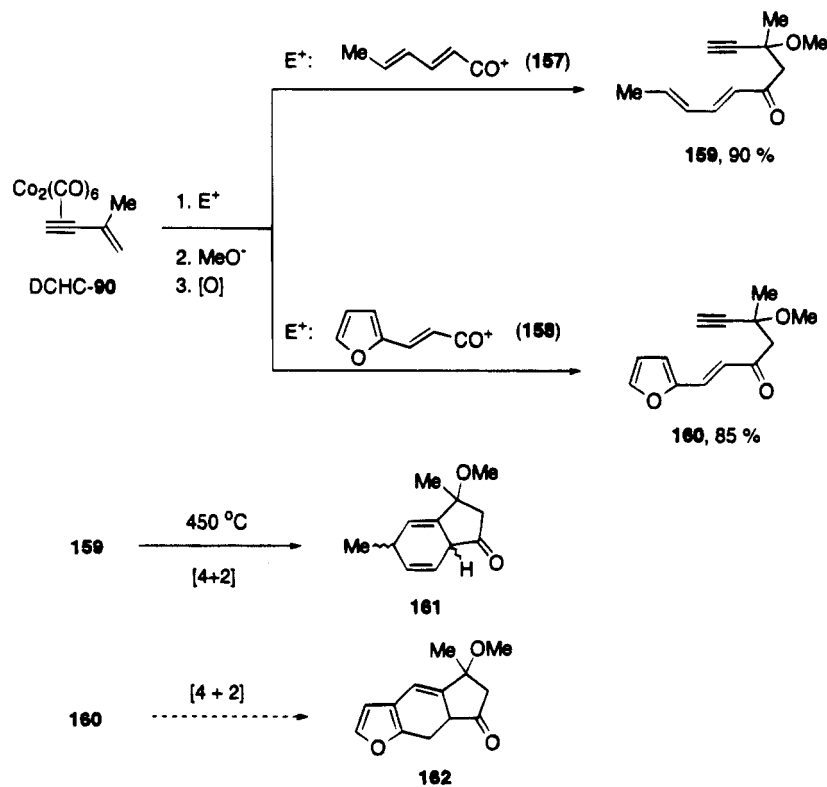

these substrates met with little success, obviously due to the deactivation of diene moiety by a conjugated carbonyl group. In fact IMDA reaction was shown to proceed with adduct **159** only at elevated

temperature (flash pyrolysis) and gave the bicyclic product **161** as a mixture of isomers in ca. 30% yield.<sup>23</sup> The thermal lability of adduct **160** precluded the opportunity of its direct utilization as a substrate

Scheme 30

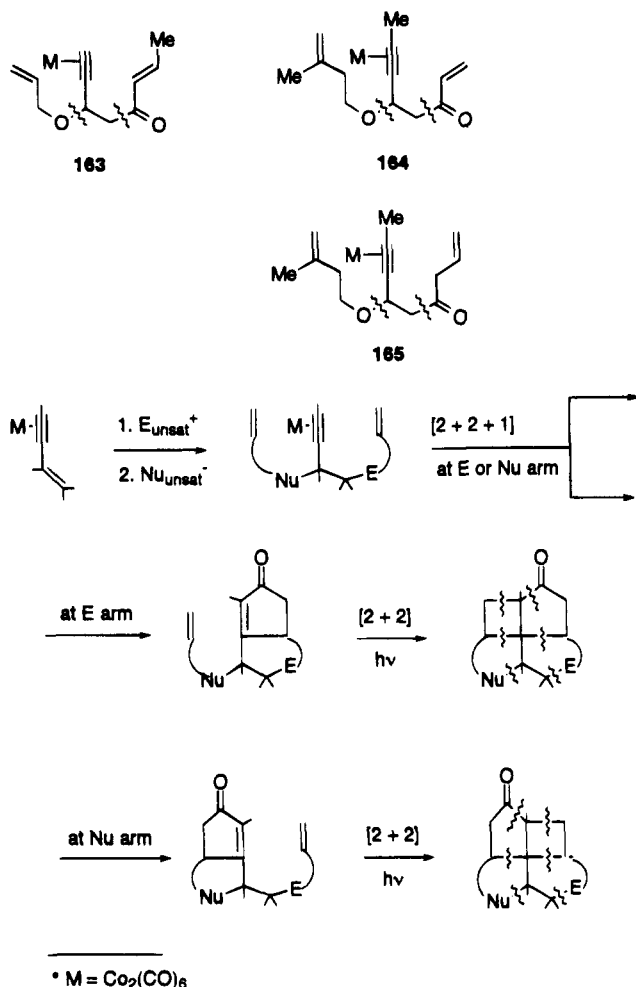

for IMDA reaction. Our current efforts are aimed at the appropriate modification of the functionality pattern in **160** to make it amenable to IMDA reaction with an ultimate goal of preparing bicyclic products like **162**, promising intermediates for the synthesis of psoralene analogs.<sup>24</sup>

The sequences considered above in Scheme 23 referred to synthetic options available via an utilization of either E<sub>unsat</sub> or Nu<sub>unsat</sub> as the addends in the initial Ad<sub>E</sub> process. A more sophisticated protocol can be elaborated if both these addends bear unsaturation. Preliminary data showed that the standard procedure of the stepwise Ad<sub>E</sub> reaction might serve as a reliable route for the preparation of the respective polyunsaturated adducts as, e.g. **163**–**165** (Scheme 30) in acceptable 60–70% yields.<sup>20b</sup> The DCHC complexes of dienyne thus prepared represent a promising substrates for the sequential cycloadditions like IMPK reaction plus [2 + 2] cycloadditions which should lead ultimately to the *total utilization of the potential of the starting 1,3-enynes as hexadentate synthons* as shown in generalized form in Scheme 30.

As is shown in Scheme 30, the IMPK reaction can take either of the two alternative pathways and thus the main problem for the practical realization of the suggested protocol relates to the control over the selectivity of this reaction. Studies with model substrates,<sup>25a</sup> e.g. **166** and **167** (Scheme 31), revealed that variations in the tether length between triple

Scheme 31

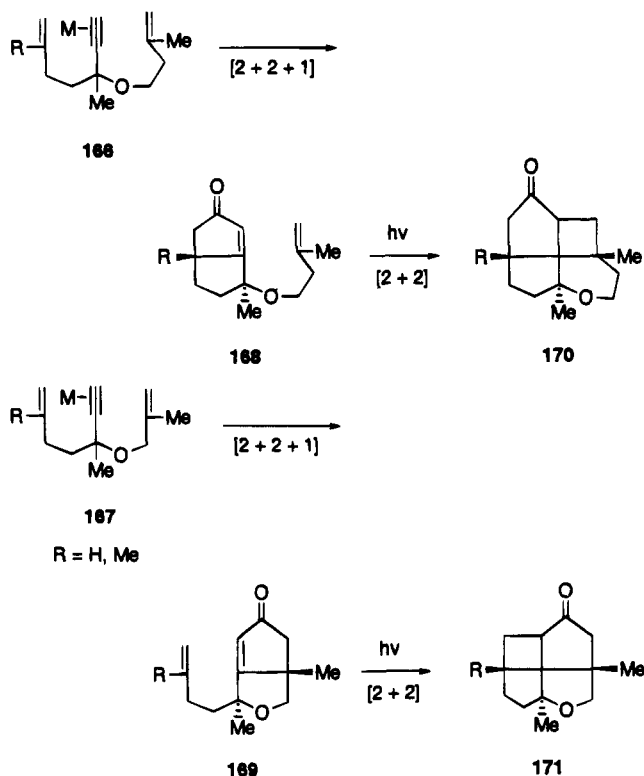

and double bonds as well as the nature of the tethering links might serve as control elements for channeling the IMPK reaction along the required route.<sup>25b</sup> Thus adduct **166** underwent an exclusive IMPK reaction with the involvement of the “left” ennoity to give the adduct **168**, while a highly selective formation of **169** was achieved via IMPK reaction with the “right” half of the substrate **167** (yields 50–65%). The bicyclic adducts **168** and **169** possess enone and alkane moiety properly positioned for the subsequent intramolecular enone–olefin [2 + 2] cycloaddition and the latter reaction proceeded with a high efficiency<sup>25b</sup> as is typical for this process.<sup>25c</sup> Using this route a set of oxa analogs of fenestrane,<sup>25a</sup> e.g. **170** and **171**, was prepared.

These results clearly demonstrated the viability of the suggested protocol and provide us with some key leads concerning the available options to controlling its final outcome. Our current studies are aimed at the preparation of a set of various Ad<sub>E</sub> adducts with a specifically designed structure in the E and Nu arms in order to secure the required course of sequential cycloadditions leading to several types of polycyclic target structures.

## V. Concluding Remarks

The results presented in this paper substantiated the validity of the initial concept about the prerequisites, required to perform Ad<sub>E</sub> reactions as a sequence of two steps. Both approaches, cases A and B, are viable. They have specific limitations and are actually complementary in their application. Thus case A implies the utilization of electrophiles capable of bridging but have no intrinsic restrictions on the nature of the starting alkenes or the nucleophiles used at the second step of the Ad<sub>E</sub> reaction. Case B

is essentially free of any limitations with regard to the nature of both electrophiles and nucleophiles, but it envisages the utilization of unsaturated substrates containing cation-stabilizing groups attached to the double bond.

It also is to be emphasized that since the phenomena of carbocation stabilization is fairly general in its scope quite a number of other electrophilic species as well as unsaturated substrates can be used in a manner similar to that described above. In this respect organotransition metal chemistry is by far the most promising area of studies, both due to the diversity of the ways to achieve efficient cation stabilization and to the versatility of the reactivity patterns available for metal complexed organic moieties. Among numerous reactions leading to the formation of carbocationic intermediates stabilized by transition metal complexes one might find examples related both to case A and B.<sup>26</sup> However generally these studies can be hardly considered in the terms of a stepwise Ad<sub>E</sub> process and thus were not included in the present review.<sup>27</sup>

Finally a more general comment seems to be warranted. Historically the idea of two step Ad<sub>E</sub> reaction appeared as a purely speculative concept extremely useful for the understanding of a broad spectrum of experimental data. However the unquestionable descriptive usefulness of this mechanism somehow overshadowed its conceptual importance and tremendous synthetic potential hidden in its implications. The approach outlined in the present review was actually based on a very literal or even naive idea of channeling the reaction along the route prescribed to it by existing theory. In a way it was an attempt to teach the reaction the rules of conduct and we hope that at least partially this lesson was learned.

## VII. Abbreviations

Ad <sub>E</sub>	electrophilic addition reaction
Ad <sub>N</sub>	nucleophilic addition reaction
APC	adsorption promoted condition
CAI	stabilized carbanionoid intermediate
CCI	carbocationic intermediate
DCHC	dicobalthexacarbonyl
E	electrophile
E <sub>c</sub>	carbon electrophile
ESI	episulfonium ion
ext	external
EWG	electron withdrawing group
Fp	dicarbonyl dicyclopentadienyliron
IMPK	intramolecular Pauson-Khand reaction
int	internal
LA	Lewis acid
M isomer	Markovnikov isomer
Nu	nucleophile
Nu <sub>c</sub>	carbon nucleophile
Tf	triflate
TPS	thiophanium salt
TS	transition state
TMS	trimethylsilyl
unsat	unsaturated

## VII. Acknowledgments

The authors gratefully acknowledge the National Science Foundation (grant no. 8921358), the Donors of The Petroleum Research Fund, administrated by

the American Chemical Society (grant no. 27420-B1), and the International Science Foundation (Long Term Project MNK000, Supplementary Grant Program SAQ000). We are also indebted to CIES and the Fulbright Scholar Program. We are very grateful to our colleagues who most skillfully executed the experimental portion of this study and who are recognized as co-authors on our publications.

## VIII. References

- (1) (a) For a comprehensive summary, see: Perlmutter, P. *Conjugate Addition Reactions in Organic Synthesis, Tetrahedron Organic Chemistry Series*; Pergamon: Oxford, 1992; Vol. 9. See also reviews: (b) Posner, G. H. *Chem. Rev.* **1986**, *86*, 831. (c) Fuchs, P. L.; Braish, T. F. *Chem. Rev.* **1986**, *86*, 903. (d) Taylor, R. J. K. *Synthesis* **1985**, 364.
- (2) For the prehistory of these studies, see: Smit, W. A. Cationoid Reagents and Intermediates in Electrophilic Additions to Double and Triple Carbon-Carbon Bonds. In *Sov. Sci. Rev. B Chem.* **1985**, *7*, 155. Vol'pin, M. E., Ed.; Harwood Academic Publisher GmbH and OPA: Amsterdam.
- (3) (a) De la Mare, P. B. D.; Bolton, R. *Electrophilic Additions to Unsaturated Systems*; Elsevier: Amsterdam, 1982. (b) Freeman, F. *Chem. Rev.* **1975**, *75*, 439.
- (4) Robinson, R. In *CIBA Foundation Symposium on the Biosynthesis of Terpenes and Sterols*; Wolstenholme, G. E., O'Connor, M. J., Churchill, A., Eds.; LTD: London, 1959; p 16.
- (5) (a) For the leading references, see: Vogel, P. Carbocation Chemistry. In *Studies in Organic Chemistry*; Elsevier: Amsterdam, 1985; Vol. 21, p 426. (b) Olah, G. A.; Quinn, H. W.; Kuhn, S. J. *J. Am. Chem. Soc.* **1960**, *82*, 426. (c) Olah, G. A. *Halonium Ions*; Wiley Interscience: New York, 1975.
- (6) (a) Smit, W. A.; Semenovskiy, A. V.; Kucherov, V. F.; Chernova, T. N.; Krimer, M. Z.; Lubinskaya, O. V. *Tetrahedron Lett.* **1971**, 3101. (b) An excellent overview of the problems encountered at carbenium ion addition to alkenes and discussion of prerequisites required for the formation of 1:1 adducts is given in: Mayr, H. *Angew. Chem., Int. Ed. Engl.* **1990**, *29*, 1371. (c) See also a review: Mayr, H. Control of Electrophilicity in Aliphatic Friedel Crafts Reactions. In *Selectivities in Lewis Acid Promoted Reactions*; Schinzer, D., Ed.; Kluwer Academic Publishers: Dordrecht, 1989; p 21 and references cited therein.
- (7) (a) Smit, W. A.; Semenovskiy, A. V.; Lubinskaya, O. V.; Kucherov, V. F. *Dokl. Acad. Nauk SSSR* **1972**, *203*, 604; *Chem. Abstr.* **1972**, *77*, 87955b. (b) Hoffmann, H. M. R.; Tsushima, T. *J. Am. Chem. Soc.* **1977**, *99*, 6008. (c) Mustafaeva, M. T.; Kuzovkin, V. A.; Smit, W. A.; Semenovskiy, A. V.; Kucherov, V. F. *Dokl. Acad. Nauk SSSR* **1973**, *208*, 1103; *Chem. Abstr.* **1973**, *78*, 147250a. (d) Krimer, M. Z.; Smit, W. A.; Semenovskiy, A. V.; Bogdanov, V. A.; Kucherov, V. F. *Izv. Acad. Nauk SSSR, Ser. Khim.* **1968**, 866; *Chem. Abstr.* **1967**, *69*, 59402k. (e) Lubinskaya, O. V.; Shashkov, A. S.; Chertkov, V. A.; Smit, W. A. *Synthesis* **1976**, 742. (f) Anfilogova, S. N.; Frolov, E. B.; Luzikov, Yu. N.; Balenkova, E. S. *Zh. Org. Khim.* **1979**, *15*, 1432; *Chem. Abstr.* **1979**, *91*, 174862b. (g) Schegolev, A. A.; Smit, W. A.; Roitburd, G. V.; Kucherov, V. F. *Tetrahedron Lett.* **1974**, 3373. (h) Kanischev, M. I.; Schegolev, A. A.; Smit, W. A.; Caple, R.; Kelner, M. J. *J. Am. Chem. Soc.* **1979**, *101*, 5660. (i) Schegolev, A. A.; Smit, W. A.; Khurshudyan, S. A.; Chertkov, V. A.; Kucherov, V. F. *Synthesis* **1977**, 324. (j) Roitburd, G. V.; Smit, W. A.; Semenovskiy, A. V.; Schegolev, A. A.; Kucherov, V. F.; Chizhov, O. S.; Kadentsev, V. I. *Tetrahedron Lett.* **1972**, 4935.
- (8) Caple, R. Utilization of Stepwise Ad<sub>E</sub> reactions in Designing Organic Synthesis. In *Organic Synthesis: Modern Trends*; Chizhov, O. V., Ed.; Blackwell Scientific Publications: London, 1987; p 119 and references given therein.
- (9) Data for the cyclizations initiated by the following electrophiles: (a) Hal<sup>+</sup>, Bartlett, P. A.; Meadows, J. D.; Ottow, E. *J. Am. Chem. Soc.* **1984**, *106*, 5304. (b) ArS<sup>+</sup>, Mustafaeva, M. T.; Smit, W. A.; Kucherov, V. F. *Izv. Acad. Nauk SSSR, Ser. Khim.* **1973**, 1349; *Chem. Abstr.* **1973**, *79*, 105431a. See also: Edstrom, E. D.; Livinghouse, T. J. *Org. Chem.* **1987**, *52*, 949. Nicolaou, K. C.; Seitz, S. P.; Sipio, W. J.; Blount, J. F. *J. Am. Chem. Soc.* **1979**, *101*, 3884. (c) Hg<sup>+</sup>, Kurbanov, M.; Semenovskiy, A. V.; Smit, W. A.; Schmelev, L. V.; Kucherov, V. F. *Tetrahedron Lett.* **1972**, 2175. Mustafaeva, M. T.; Smit, W. A.; Semenovskiy, A. V.; Kucherov, V. F. *Izv. Acad. Nauk SSSR, Ser. Khim.* **1973**, 1151; *Chem. Abstr.* **1973**, *79*, 77795b. See also: McMurry, J. E.; Erion, M. D. *J. Am. Chem. Soc.* **1985**, *107*, 2712.
- (10) (a) Smit, W. A.; Krimer, M. Z.; Vorobieva, E. A. *Tetrahedron Lett.* **1975**, 2451. (b) Gybin, A. S.; Krimer, M. Z.; Smit, W. A.; Bogdanov, V. S.; Vorobieva, E. A. *Izvestia Acad. Nauk SSSR, Ser. Khim.* **1979**, 563; *Chem. Abstr.* **1979**, *91*, 20204b. (c) Gybin, A. S.; Smit, W. A.; Bogdanov, V. S.; Krimer, M. Z. *Izvestia Acad. Nauk SSSR, Ser. Khim.* **1978**, 2156; *Chem. Abstr.* **1979**, *90*,



- 22698u. (d) Vorobieva, E. A.; Krimer, M. Z.; Smit, W. A. *Izv. Acad. Nauk SSSR, Ser. Khim.* **1976**, 2743; *Chem. Abstr.* **1977**, 86, 155102j. (e) Gybin, A. S.; Smit, W. A.; Bogdanov, V. S.; Krimer, M. Z. *Izv. Acad. Nauk SSSR, Ser. Khim.* **1979**, 2521; *Chem. Abstr.* **1980**, 93, 7928n. (f) Kalyan, Y. B.; Smit, W. A. *Izv. Acad. Nauk SSSR, Ser. Khim.* **1979**, 2301; *Chem. Abstr.* **1980**, 92, 146389e. (g) Smit, W. A.; Gybin, A. S.; Bogdanov, V. S.; Krimer, M. Z.; Vorobieva, E. A. *Tetrahedron Lett.* **1978**, 1085. See also: Gybin, A. S.; Smit, W. A.; Bogdanov, V. S.; Krimer, M. Z.; Kalyan, J. B. *Tetrahedron Lett.* **1980**, 21, 383. (h) Reynolds, P.; Zonnebelt, S.; Bakker, S.; Kellogg, R. *J. Am. Chem. Soc.* **1974**, 96, 3146. (i) Schmid, G. H.; Garratt, D. G. In *The Chemistry of Double Bonded Functional Groups*; Patai, S., Ed.; Wiley: New York, 1977; Chapter 9. (j) A summary of relevant data is given in: Smit, W. A.; Zefirov, N. S.; Bodrikov, I. V.; Krimer, M. Z. *Acc. Chem. Rev.* **1979**, 12, 282 and literature quoted. (k) Vorobieva, E. A.; Krimer, M. Z.; Smit, W. A. *Izv. Acad. Nauk SSSR, Ser. Khim.* **1976**, 1318; *Chem. Abstr.* **1976**, 85, 177148k. (l) Borisova, G. N.; Borisov, A. V.; Lutsenko, A. I.; Smit, W. A.; Bodrikov, I. V. *Zh. Org. Khim.* **1988**, 24, 2457; *Chem. Abstr.* **1989**, 110, 211850e. (m) Gybin, A. S.; Smit, W. A.; Krimer, M. Z.; Zefirov, N. S.; Novgorodtseva, L. A.; Sadovaya, N. K. *Tetrahedron* **1980**, 1361. (n) Bolster, J.; Kellogg, R. M. *J. Chem. Soc., Chem. Commun.* **1978**, 630. (o) Bodrikov, I. V.; Borisov, A. V.; Smit, W. A.; Lutsenko, A. I. *Tetrahedron Lett.* **1984**, 25, 4983. (p) Dewar, M. J. S.; Ford, G. P. *J. Am. Chem. Soc.* **1979**, 101, 783. (q) Faustov, V. I.; Smit, W. A. *Izv. Acad. Nauk SSSR, Ser. Khim.* **1989**, 1573–1585; *Chem. Abstr.* **1990**, 112, 97742k.
- (11) (a) Reetz, M. T.; Seitz, T. *Angew. Chem., Int. Ed. Engl.* **1987**, 26, 1028. (b) Trost, B. M.; Martin, S. J. *J. Am. Chem. Soc.* **1984**, 106, 4263.
- (12) (a) Ibragimov, M. A.; Smit, W. A.; Gybin, A. S.; Krimer, M. Z. *Izv. Acad. Nauk SSSR, Ser. Khim.* **1983**, 161; *Chem. Abstr.* **1983**, 98, 178846s. (b) In several cases a substantial amount of products ArSAr<sup>1</sup> formed due to the competing attack of nucleophile at the sulfur atom of the ESI intermediates were also formed, but their amount could be minimized with the use of sterically demanding Ar substituents (as for example Mz) at the sulfenium center.<sup>12a</sup> (c) Ibragimov, M. A.; Lubinskaya, O. V.; Smit, W. A. *Izv. Acad. Nauk SSSR, Ser. Khim.* **1983**, 1204; *Chem. Abstr.* **1983**, 99, 105061t. (d) Ibragimov, M. A.; Smit, W. A. *Tetrahedron Lett.* **1983**, 24, 961. (e) Ibragimov, M. A.; Lubinskaya, O. V.; Smit, W. A. *Izv. Acad. Nauk SSSR, Ser. Khim.* **1983**, 1839; *Chem. Abstr.* **1983**, 99, 212577n. (f) Ibragimov, M. A.; Smit, W. A.; Lazareva, M. I. *Izv. Acad. Nauk SSSR, Ser. Khim.* **1985**, 392; *Chem. Abstr.* **1985**, 103, 21882z. (g) Patel, S. K.; Paterson, I. *Tetrahedron Lett.* **1983**, 24, 1315. (h) Alexander, R. P.; Paterson, I. *Tetrahedron Lett.* **1983**, 24, 5911. (i) Smoliakova, I. P.; Smit, W. A. *Izv. Acad. Nauk SSSR, Ser. Khim.* **1985**, 485; *Chem. Abstr.* **1985**, 103, 5955v. (j) Smoliakova, I. P.; Smit, W. A. *Izv. Acad. Nauk SSSR, Ser. Khim.* **1988**, 198; *Chem. Abstr.* **1988**, 109, 169581v. (k) Ibragimov, M. A.; Lazareva, M. I.; Smit, W. A. *Synthesis* **1985**, 880.
- (13) (a) Smoliakova, I. P.; Smit, W. A.; Lutsenko, A. I. *Izv. Acad. Nauk SSSR, Ser. Khim.* **1987**, 119; *Chem. Abstr.* **1987**, 107, 175155j. (b) Smoliakova, I. P.; Smit, W. A.; Lutsenko, A. I.; Daeva, E. D. *Izv. Acad. Nauk SSSR, Ser. Khim.* **1990**, 114; *Chem. Abstr.* **1990**, 113, 97110. (c) Smoliakova, I. P.; Smit, W. A. *Izv. Acad. Nauk SSSR, Ser. Khim.* **1988**, 2792; *Chem. Abstr.* **1989**, 110, 231204a. (d) Smoliakova, I. P.; Smit, W. A. *Izv. Acad. Nauk SSSR, Ser. Khim.* **1990**, 2036; *Chem. Abstr.* **1990**, 112, 118356e. (e) Fisher, P. In *The Chemistry of Ethers, Crown Ethers, Hydroxyl Groups, and Their Sulfur Analogs*; Patai, S., Ed.; Wiley: New York, 1980; Supplement E, Chapter 17, p 761. (f) In the independent studies related 1-aryl-2,4-diarylthiophanium salts were isolated as stable perchlorates from the LiClO<sub>4</sub>-catalyzed reaction of the respective styryl-ArS<sup>+</sup> adducts with styrenes, see: Bodrikov, I. V.; Chumakov, L. V.; Pryadilova, A. N.; Nisnevich, G. A.; Gatilov, Y. V.; Bagryanskaya, I. Y.; Mamatiuk, V. I.; Dolenko, G. N.; Barhash, V. A. *Zh. Org. Khim.* **1984**, 20, 2257; *Chem. Abstr.* **1985**, 102, 184934m. (g) Abundant experimental data indicate that regular thiophanium salts react sluggishly with weak electrophiles like Hal<sup>+</sup> or HO<sup>+</sup> and reveal behavior of C-H acids toward strong bases or organic nucleophiles like Li<sup>-</sup> or Mg-organic derivatives; see for a review: Dittmer, D. C.; Patwardhan, B. H. *Cyclic Sulfonium Salts. In The Chemistry of Sulfonium Group*; Stirling, C. J. M., Patai, S., Eds.; Wiley: New York, 1981; Chapter 13.
- (14) (a) Smoliakova, I. P.; Smit, W. A.; Bubnov, Y. N.; Shashkov, A. S. *Izv. Acad. Nauk SSSR, Ser. Khim.* **1991**, 1100; *Chem. Abstr.* **1991**, 115, 158890t. (b) Smoliakova, I. P.; Smit, W. A.; Osinov, B. *Tetrahedron Lett.* **1991**, 32, 2601. (c) Smoliakova, I. P.; Caple, R.; Magnuson, V. R.; Polyakov, V. R.; Smit, W. A.; Shashkov, A. S.; Ohinov, B. D. *J. Chem. Soc. Perkin Trans. 1* **1995**, submitted for publication. (d) See, for a review: Genari, C. *Selectivities in Lewis Acid Promoted Reactions*; Schinzer, D., Ed.; Kluwer Academic Publishers: Dordrecht, 1989. See also: Reetz, M. T. *Angew. Chem., Int. Ed. Engl.* **1984**, 23, 566.
- (15) (a) See discussion and a nearly exhaustive list of references in: Ramesh, S.; Kalia, N.; Grewal, G.; Franck, R. W. *J. Org. Chem.* **1990**, 55, 5. (b) Smoliakova, I. P.; Smit, W. A.; Zal'chenko, E. A.; Chizhov, O. S.; Shashkov, A. S.; Caple, R.; Sharpe, S.; Kuehl, C. *Tetrahedron Lett.* **1993**, 34, 3047. (c) Smoliakova, I. P.; Smit, W. A.; Gong, J.; Shashkov, A. S.; Caple, R. *J. Org. Chem.*, manuscript in preparation. (d) Smoliakova, I. P. Unpublished data. (e) For a review on C-glycosides, see: Postema, M. H. D. *Tetrahedron* **1992**, 48, 8545.
- (16) See, for a review: Nicholas, K. M. *Acc. Chem. Res.* **1987**, 20, 207.
- (17) (a) Schegolev, A. A.; Smit, W. A.; Kalyan, Y. B.; Krimer, M. Z.; Caple, R. *Tetrahedron Lett.* **1982**, 23, 4419. (b) Schegolev, A. A.; Smit, W. A.; Mikaelian, G. S.; Gybin, A. S.; Kalyan, Y. B.; Krimer, M. Z.; Caple, R. *Izv. Acad. Nauk SSSR, Ser. Khim.* **1984**, 2571; *Chem. Abstr.* **1985**, 102, 132247v. (c) Mikaelian, G. S.; Gybin, A. S.; Smit, W. A.; Caple, R. *Tetrahedron Lett.* **1985**, 26, 1269. (d) Mikaelian, G. S.; Gybin, A. S.; Smit, W. A. *Izv. Acad. Nauk SSSR, Ser. Khim.* **1985**, 2277; *Chem. Abstr.* **1987**, 106, 17849p. (e) Mikaelian, G. S.; Smit, W. A.; Batsanov, A. S.; Struchkov, Y. T. *Izv. Acad. Nauk SSSR, Ser. Khim.* **1984**, 2105; *Chem. Abstr.* **1985**, 102, 113677u. (f) Smit, W. A.; Schegolev, A. A.; Gybin, A. S.; Mikaelian, G. S.; Caple, R. *Synthesis* **1984**, 887. (g) Gybin, A. S. Unpublished data.
- (18) For a review, see: Neunhoeffer, H.; Franke, W. K. *Konjugierte en-yne (Conjugated enynes)*. In *Methoden Org. Chem.* (Houben-Weyl) **1972**, v. 1.
- (19) See for a review: Schore, N. E. The Pauson-Khand Cycloaddition Reaction for Synthesis of Cyclopentenones. In *Organic Reactions*; Paquette, L. A., Ed.; Wiley: New York, 1991; Chapter 1.
- (20) (a) Smit, W. A.; Gybin, A. S.; Shashkov, A. S.; Struchkov, Y. T.; Kuz'mina, L. G.; Mikaelian, G. S.; Caple, R.; Swanson, E. D. *Tetrahedron Lett.* **1986**, 27, 1241. (b) Smit, W. A.; Simonian, S. O.; Mikaelian, G. S.; Mamian, S. S.; Gybin, A. S.; Shashkov, A. S.; Caple, R. *Izv. Acad. Nauk SSSR, Ser. Khim.* **1989**, 334; *Chem. Abstr.* **1989**, 111, 174359. (c) Billington, D. C.; Willisson, D. *Tetrahedron Lett.* **1984**, 25, 4041. See also references to the original Pauson-Khand procedure in the ref 19. (d) Simonian, S. O.; Smit, W. A.; Gybin, A. S.; Shashkov, A. S.; Mikaelian, G. S.; Tarasov, V. A.; Ibragimov, I. I.; Caple, R.; Froen, D. E. *Tetrahedron Lett.* **1986**, 27, 1245. (e) Smit, W. A.; Simonian, S. O.; Tarasov, V. A.; Gybin, A. S.; Mikaelian, G. S.; Shashkov, A. S.; Mamian, S. S.; Ibragimov, I. I.; Caple, R. *Izv. Acad. Nauk SSSR, Ser. Khim.* **1988**, 2802; *Chem. Abstr.* **1989**, 111, 97000w. (f) Smit, W. A.; Simonian, S. O.; Tarasov, V. A.; Mikaelian, G. S.; Gybin, A. S.; Ibragimov, I. I.; Caple, R.; Froen, D. E.; Kreager, A. *Synthesis* **1989**, 472. (g) Gybin, A. S.; Smit, W. A.; Veretenov, A. L.; Simonian, S. O.; Shashkov, A. S.; Struchkov, Y. T.; Kuz'mina, L. G.; Caple, R. *Izv. Acad. Nauk SSSR, Ser. Khim.* **1989**, 2756; *Chem. Abstr.* **1990**, 113, 24181n. (h) Veretenov, A. L.; Gybin, A. S.; Smit, W. A.; Chertkov, V. S.; Shashkov, A. S. *Izv. Acad. Nauk SSSR, Ser. Khim.* **1989**, 1879; *Chem. Abstr.* **1990**, 112, 178137u. (i) Magnus, P.; Principe, L. M. *Tetrahedron Lett.* **1985**, 26, 4851.
- (21) General reviews: Paquette, L. A. *Top. Curr. Chem.* **1979**, 79, 41; **1984**, 119, 1.
- (22) (a) Smit, W. A.; Gybin, A. S.; Simonian, S. O.; Veretenov, A. L.; Shashkov, A. S. *Izv. Acad. Nauk SSSR, Ser. Khim.* **1987**, 232; *Chem. Abstr.* **1987**, 107, 217122d. (b) Gybin, A. S.; Smit, W. A.; Caple, R.; Veretenov, A. L.; Shashkov, A. S.; Vorontsova, L. G.; Kurella, M. G.; Chertkov, V. S.; Carapetyan, A. A.; Kosnikov, A. Y.; Alexanyan, M. S.; Lindeman, S. V.; Panov, V. N.; Maleev, A. V.; Struchkov, Y. T.; Shaper, S. M. *J. Am. Chem. Soc.* **1992**, 114, 5555. (c) Schore, N. E.; Knudsen, M. J. *J. Org. Chem.* **1987**, 52, 569. (d) Schore, N. E.; Rowley, E. G. *J. Am. Chem. Soc.* **1988**, 110, 5224. (e) Veretenov, A. L.; Smit, W. A.; Vorontsova, L. G.; Kurella, M. G.; Caple, R.; Gybin, A. S. *Tetrahedron Lett.* **1991**, 32, 2109. (f) Mehta, G.; Rao, K. S.; Reddy, M. S. *J. Chem. Soc., Perkin Trans.* **1991**, 693. (g) Corey, E. J.; Desai, M. C.; Engler, T. A. *J. Am. Chem. Soc.* **1985**, 107, 4339.
- (23) Wittala, K.; Smit, W. A.; Gybin, A. S.; Caple, R. Unpublished data.
- (24) Hayakawa, K.; Yodo, M.; Ohsuki, S.; Kanematsu, K. *J. Am. Chem. Soc.* **1984**, 106, 6735.
- (25) (a) Smit, W. A.; Simonian, S. O.; Tarasov, V. A.; Shashkov, A. S.; Mamian, S. S.; Gybin, A. S.; Ibragimov, I. I. *Izv. Acad. Nauk SSSR, Ser. Khim.* **1988**, 2796; *Chem. Abstr.* **1989**, 111, 133673d. (b) Smit, W. A.; Buchanyuk, S. M.; Simonian, S. O.; Shashkov, A. S.; Struchkov, Y. T.; Yanovsky, A. I.; Caple, R.; Gybin, A. S.; Anderson, L. G.; Whiteford, J. A. *Tetrahedron Lett.* **1991**, 32, 2105. (c) Cf. data in a review: Schore, N. K. *Chem. Rev.* **1988**, 88, 1081. (d) For leading references see: Venepalli, B. R.; Agosta, W. C. *Chem. Rev.* **1987**, 87, 399.
- (26) See, for the examples, chapters 9.9 and 10.5 in ref 5a; see also: Pearson, A. J. *Metallo-organic Chemistry*; Wiley-Interscience: Chichester, 1985. Davies, S. G. *Organotransition Metal Chemistry: Application To Organic Synthesis*; Pergamon Press: Oxford, 1982. Harrington, P. J. *Transition Metals in Total Synthesis*; Wiley-Interscience: Chichester, 1990.

(27) Some pertinent data can be found in reviews: Rosenblum, M. *Acc. Chem. Res.* **1974**, 122. Rosenblum, M. *J. Organomet. Chem.* **1986**, 300, 191. For a representative example, see also: Lennon, P. J.; Rosan, A. M.; Rosenblum, M. *J. Am. Chem. Soc.* **1977**, 99, 8426. Cutler, A.; Ehntholt, D.; Lennon, K.; Nicholas, K.; Marten, D.; Madhavarao, M.; Radhu, S.; Rosan, A. M.;

Rosenblum, M. *J. Am. Chem. Soc.* **1975**, 97, 3149. Bucheister, A.; Klemarczyk, P.; Rosenblum, M. *Organometallics* **1982**, 1, 1679. Rosenblum, M.; Watkins, J. C. *J. Am. Chem. Soc.* **1990**, 112, 6316. Celebusky, J.; Rosenblum, M. *Tetrahedron* **1985**, 41, 5741. Lennon, P. J.; Rosan, A.; Rosenblum, M.; Tankrede, J.; Waterman, P. *J. Am. Chem. Soc.* **1980**, 102, 2033.